



Installation and Operation Manual

AMU50-001 Audio Management Unit



SM76

ISSUE 1.04

Northern Airborne Technology Ltd.
1925 Kirschner Road
Kelowna, BC, Canada.
V1Y 4N7
Telephone (250) 763-2232
Facsimile (250) 762-3374

Issued on the authority of Northern Airborne Technology Ltd.

Copyright 2009



**AMU50-001 Audio Management Unit
SM76 Installation and Operation Manual**

Table of Contents

Section	Title	Page
1.	Description	
1.1	Introduction	1-1
1.2	Product Description	1-1
1.2.1	System Information	1-1
1.2.2	System Configuration	1-1
1.3	Design Features	1-2
1.4	Specifications	1-3
1.4.1	Electrical Specifications	1-3
1.4.2	Physical Specifications	1-8
1.4.3	Environmental Specifications	1-8
1.4.4	Product Approval	1-8
1.4.5	DACS System Equipment	1-9
2.	Installation	
2.1	Introduction	2-1
2.2	Unpacking and Inspection	2-1
2.2.1	Warranty	2-1
2.3	Continued Airworthiness	2-1
2.4	Installation Procedures	2-1
2.4.1	Warnings	2-1
2.4.2	Cautions	2-2
2.4.3	Mounting	2-3
2.4.4	Cabling and Wiring	2-3
2.4.5	Post Installation Checks	2-9
2.5	Adjustments and Configuration	2-10
2.5.1	Maintenance Mode	2-10
2.5.2	DevCs Configurable Settings	2-11
2.6	Accessories Required But Not Supplied	2-12
2.7	Installation Drawings	2-13
3.	Operation	
3.1	Introduction	3-1
3.2	General Information	3-1
3.3	Control Functionality	3-1
3.3.1	Audio Control Panels	3-1
3.3.2	PTT Keys	3-1
3.3.3	Transmit Priority	3-2
3.3.4	Aural Alerts	3-2
3.3.5	Remote Alert Cancel Switch	3-2
3.3.6	Remote Alert Inhibit Switch	3-2
3.3.7	Audio Muting	3-3
3.3.8	EMERG/BACKUP Indicator	3-3
3.3.9	Passenger Intercom	3-3
3.3.10	Passenger ICS Volume	3-3
3.3.11	Winchman Select	3-3
3.3.12	NORM Call; High Priority Call; ISO Override	3-3
3.3.13	Other Switches and Indicators	3-4



AMU50-001 Audio Management Unit SM76 Installation and Operation Manual

Section 1 Description

1.1 Introduction

Information in this section consists of product description, design features and specifications for the AMU50-001 Audio Management Unit (AMU50). All derivative product information shall be contained in the applicable manual supplement, which may be obtained from Northern Airborne Technology Ltd as required.

Review all notes, warnings and cautions.

Note: This manual contains information applicable to units MOD 12 and above (s/n 3000 and above). For information applicable to units MOD 11 and below (s/n 2999 and below) contact the product support department at Northern Airborne Technology Ltd.

1.2 Product Description

1.2.1 System Information

The Digital Audio Communication System (DACS) is a management system that distributes and controls all of the transceiver, receiver and warning source audio in an aircraft. It enables the transmission of microphone audio to a selected Transceiver and distributes all Inter-Communication System (ICS) audio.

The primary component of the DACS is the AMU50. Connected to this Line Replaceable Unit (LRU) are the user headsets, the transceivers, the receivers, and the Audio Control Panels (ACP). The AMU50 also has an audio accessory port that enables the connection of a unit for providing ICS audio in the cabin.

The DACS architecture is a star configuration to prevent the loss of the entire system due to failure of one connection. It provides a redundant power supply, redundant amplifiers for the crew microphones (MIC) and headphones (PHN), redundant amplifiers for the first three direct audio inputs, and multiple modes of operation.

The Power-On Built-In-Test (PBIT) function provides fault analysis down to the LRU level, while the Continuous Built-In-Test (CBIT) is a background task that verifies hardware functionality on an ongoing basis.

1.2.2 System Configuration

The DACS is configurable on a per installation basis using the AMU50 connected via a Universal Serial Bus (USB) port to a Personal Computer (PC) running the DACS Device Configuration Software (DevCs). System configuration is stored in the AMU50 and the Remote Memory (RM).

The DevCs is a PC application that allows a user to control adjustments and functions of the DACS Digital Audio Communication System equipment including the AMU50 and the ACPs. The PC Application provides a graphical user interface for the display and control of the adjustment levels and function behaviour or configuration. The configuration can be saved as a file. The configuration can be written to, and read from, the DACS equipment over a serial data communication buss.



AMU50-001 Audio Management Unit SM76 Installation and Operation Manual

1.3 Design Features

The AMU50 is comprised of three subassemblies two of which support two 50 pin D-Min connectors each. Power distribution, radio, and headset connections are evenly distributed across the connectors to ensure the loss of one connector does not disable the entire system.

The Audio Management Unit supports up to six separate ACPs. The AMU50 is responsible for providing power to each ACP53 and completing all of the audio processing to and from the ACP53 including MIC and PHN audio, user switch selections, and level adjustments. The maximum Receive Audio input level and the Transmit MIC output level are both adjustable using the DACS DevCs.

The AMU50 provides an audio accessory serial data port for connecting a passenger intercom device.

Support is provided for a Normal ICS Call input, a High Priority ICS Call input, and an Isolation Override input. The Call inputs are used by passengers without ACP to call the crew when they have been isolated. When the Isolation Override input becomes active, the Isolation Mode is temporarily suspended and the passengers can communicate with the crew members.

The Voice Operated ICS (VOX) level for the passengers not assigned to an ACP53 is set in the DACS DevCs. The highest VOX level threshold shall act as the keyed mode of operation and the VOX circuit shall not gate the microphone audio. In this mode the MIC audio can only be gated using the ICS PTT input. When the lowest VOX level is reached, the ICS shall still be gated but shall only require a small signal to open the ICS channel.

The Audio Management Unit supports six Direct Audio inputs to provide audio at a fixed level to the users. The Direct Audio inputs heard by each of the users are configurable using the DACS DevCs.

The AMU50 has an eight channel Aural Alert Generator. Each aural alert has a separate key input and the resultant aural alert signals may be either tone, voice, or tone and voice. The Aural Alert inputs are configurable, either as active HI or LO using the DACS DevCs.

The AMU50 provides a Direction Finder (DF) Blanking output. This output deactivates the DF antenna to avoid causing it damage when users transmit on any transceiver.

Two separate power supplies are provided by the AMU50. The primary power supply provides filtering and pre-regulation before distributing power to the rest of the AMU. The backup power supply provides power to specific sections of circuitry depending upon the currently selected operational mode.

A USB port is provided on the AMU50 for configuration programming. The port is also used for extracting the PBIT and CBIT results. The system configuration is downloaded into the AMU50 using the USB port and is stored in the Remote Memory enabling the replacement of the AMU50 without the need of downloading a new configuration file.

The AMU50 has three modes of operation: Normal Mode, Backup Mode, and Emergency Mode.

When the system is in Back-up mode, users 1 and 2 maintain full functionality via back-up microphone and headphone amplifiers but all other headsets and ACPs are disabled. This mode overcomes failures (such as a crew headset amplifier failure or a failure of circuitry used to support passengers) that may be adversely affecting the operation of the system.



AMU50-001 Audio Management Unit SM76 Installation and Operation Manual

In Emergency mode all ACPs are deactivated, and only User 1 and User 2 maintain a limited amount of functionality. In this mode, User 1 will be able to listen to COM1, NAV1, Direct1, Direct2, Direct3 and all alerts at a fixed level, and transmit on COM1. User 2 will be able to listen to COM2, NAV2, Direct1, Direct2, Direct3 and all alerts at a fixed level, and transmit on COM2. Both User 1 and User 2 will have keyed intercom audio at a fixed level.

Emergency mode disables the Digital Signal Processing software and provides the above functionality via analog technology.

1.4 Specifications

1.4.1 Electrical Specifications

POWER

NORM and EMERG Power Inputs (NORM +28 VDC Power, EMERG +28 VDC Power)

Normal Operating Conditions:

Nominal input voltage	28.0 Vdc
Maximum input voltage	30.3 Vdc
Minimum input voltage	22.0 Vdc
Emergency input voltage	18.0 Vdc

Abnormal Operating Conditions:

Maximum input voltage	32.2 Vdc
Minimum input voltage	20.5 Vdc

Maximum Current: 2.6 A @ 28.0 Vdc with 6 ACPs connected and lights at maximum

Power Outputs for ACP (ACP 1 PWR thru ACP 6 PWR)

Quantity:	Six
Output Voltage:	25.5 Vdc (Nominal) with a +28.0 Vdc input to the AMU50
Maximum Current:	0.25A @ 25.5 Vdc

Power Output for RM01 (RM01 PWR)

Quantity:	One
Output Voltage:	5 Vdc \pm 10% (Nominal)
Maximum Current:	0.10 A @ 5 Vdc

INPUTS

Audio Inputs

MIC Inputs

Three microphone impedances available: User 1 and User 2 microphone impedances must be the same; User 3 through User 7 microphone impedances are independently configurable.

Quantity	Seven, configured through DevCs application.
Gain	Independently adjustable from -9 dB to +6 dB of nominal input level, +/- 1dB with 15 steps of adjustment



AMU50-001 Audio Management Unit SM76 Installation and Operation Manual

Microphone (Type One) dynamic

Input Impedance 5 Ω \pm 30%
Rated Input 250 μ Vrms nominal to produce rated headphones output
Circuitry Type Differential

Microphone (Type Two) dynamic

Input Impedance 75 Ω \pm 30%
Rated Input 850 μ Vrms nominal to produce rated headphones output
Circuitry Type Differential

Microphone (Type Three) amplified dynamic/electret

Input Impedance 150 Ω \pm 10%
Rated Input 250 mVrms nominal to produce rated headphones output
Circuitry Type Single ended

Direct Audio Inputs (DIR 1 RX thru DIR 6 RX)

Quantity: Six
Input Impedance: 1000 Ω \pm 10%
Rated Input: 1 to 19.95 Vrms maximum to produce rated headphones output
Circuitry Type: Differential

Receive Audio Inputs

Quantity: Sixteen (8 transceivers and 8 receivers)
Input Impedance: 1000 Ω \pm 10%
Rated Input: 1 to 19.95 Vrms maximum to produce rated headphones output
Circuitry Type: Differential

Music Inputs (MUSIC RIGHT/LEFT RX)

Quantity: Two (one left, one right, summed to produce mono)
Input Impedance: 1000 Ω \pm 10%
Circuitry Type: Differential
Input Range 1: 400 mVrms nominal
Input Range 2: 2.5 Vrms nominal

Discrete Inputs

All discrete inputs have the following specifications unless stated otherwise.

Logic Active LO, switched ground, no external pull up required
Input Active \leq +3 Vdc
Maximum Current \leq 10 mA
Input Protection Diode protected to +45 Vdc maximum

Transmit Push-To-Talk (USER 1 TX KEY thru USER 7 TX KEY)

Quantity: Seven

ICS Push-To-Talk Inputs (USER 1 ICS KEY thru USER 7 ICS KEY)

Quantity: Seven



AMU50-001 Audio Management Unit SM76 Installation and Operation Manual

Passenger ICS Volume Inputs (PAX VOL +/-)

Quantity: Two

Aural Alert Cancellation Input (Alert Cancel)

Quantity: One

Aural Alert Inhibit Input (Alert Inhibit)

Quantity: One

Weight On Wheels Input (WEIGHT ON WHEELS)

Quantity: One

Normal Mode Enable Input (ACP 1 NORM MODE and ACP 2 NORM MODE)

Quantity: Two (one for User 1 and one for User 2)

Backup Mode Enable Input (ACP 1 BACKUP MODE and ACP 2 BACKUP MODE)

Quantity: Two (one for User 1 and one for User 2)

Winchman Select Inputs (ACP 1 WINCHMAN SELECT thru ACP 3 WINCHMAN SELECT)

Quantity: Three (associated with ACP 1 through ACP 3)

Aural Alert Inputs (Alert 1 thru Alert 8)

Quantity: Eight

Maximum Current: ≤ 10 mA

Input Protection: Diode protected to +45 Vdc maximum

Active LO Configuration (configured through the DevCs application):

Logic: Active LO, switched ground no external pull up required

Input Active: $\leq +3$ Vdc

Active HI Configuration (configured through the DevCs application):

Logic: Active HI, switched power no external pull down required

Input Active: $\geq +18$ Vdc

Normal Call Input (NORM Call in)

Quantity: One

High Priority Call Input (High Priority Call in)

Quantity: One

Isolation Over-ride Input (Isolation Over-ride in)

Quantity: One

OUTPUTS

The AMU50 provides the following outputs to the aircraft:

Audio Outputs

Headphone Outputs

Three headphone impedances available: User 1 and User 2 headphone impedances must be the same; User 3 through User 7 headphone impedances are independently configurable.

Quantity: Seven Mono PHN, configured through DevCs application.

Rated Output: >250 mW into rated load

Circuitry Type: Balanced



AMU50-001 Audio Management Unit SM76 Installation and Operation Manual

Headphone (Type One)

Load Impedance: $8 \Omega \pm 10\%$

Output Impedance: $\leq 2.25 \Omega$

Headphone (Type Two)

Load Impedance: $150 \Omega \pm 10\%$

Output Impedance: $\leq 20 \Omega$

Headphone (Type Three)

Load Impedance: $600 \Omega \pm 10\%$

Output Impedance: $\leq 60 \Omega$

Transceiver Microphone Outputs

Quantity: Eight

Output Impedance: $\leq 60 \Omega$

Circuitry Type: Balanced and AC coupled

Rated Output: 250 mVrms into $50 \Omega \pm 10\%$

Output Range: 11 mVrms to 1.1 Vrms, ≥ 160 steps, logarithmic

Composite Audio Output

Quantity: One

Output Impedance: $\leq 150 \Omega$

Rated Output: 2.5 Vrms or 500 mVrms into 600 ohms $\pm 10\%$

Circuitry Type: Balanced

Cockpit Voice Recorder Outputs (User 1 CVR and User 2 CVR)

User 1 CVR is User 1 summed MIC and headphone audio, and User 2 CVR is User 2 summed MIC and headphone audio.

Quantity: Two

Load Impedance: $5 \text{ k}\Omega \pm 10\%$

Output Impedance: $\leq 600 \Omega$ across rated frequency range

Rated Output: 500 mVrms into rated load in normal mode $\pm 10\%$

500 mVrms into rated load in emergency mode $+50\%/-30\%$

Output Level: Configurable through DevCs application, providing 40 ± 2 dB of control

Output Range:

Normal Mode: 9 mVrms to 900 mVrms, ≥ 64 steps

Emergency Mode: 10 mVrms to 900 mVrms, 65 steps

Circuitry Type: Balanced



AMU50-001 Audio Management Unit SM76 Installation and Operation Manual

Discrete Outputs

All the following outputs have these specifications unless stated otherwise.

Logic:	Active LO, switched ground
Output Active:	$\leq 2 \Omega$
Current:	1 A maximum

Transmit Push-To-Talk Outputs

Quantity:	Eight
-----------	-------

Crew Isolation Output (CREW ISO OUT)

Quantity:	One
-----------	-----

Aural Alert Active Output (ALERT ACTIVE)

Quantity:	One
-----------	-----

DF Blanking Output (DF BLANKING OUTPUT)

Quantity:	One
-----------	-----

Emergency Mode Active Output (EMERG/BACKUP OUT)

Quantity:	One
-----------	-----

BI-DIRECTIONAL PORTS

USB Port

Quantity:	One USB 2.0 (for programming)
-----------	-------------------------------

ICS Tieline

The ICS tie line can be configured (using DevCs) for analog or digital operation.

Analog:

Quantity:	One
Output Impedance:	$2000 \Omega \pm 10\%$
Rated Level:	230 mVrms into 1000 ohms $\pm 15\%$
Circuitry Type:	Balanced

Digital:

Quantity:	One
Specification:	RS422
Serial Data Protocol:	SP/DIF

1.4.1.1 Audio Performance

The AMU50 meets the requirements of FAA TSO-C139, EASA ETSO-C50c and RTCA/DO-214 Class Ib.

Audio Frequency Response: <3dB from 300 - 6000Hz

Volume Controls: 40dB of adjustment (individual receive audio and intercom audio)
30dB of adjustment (master receive audio)



AMU50-001 Audio Management Unit SM76 Installation and Operation Manual

1.4.2 Physical Specifications

Height:	56.6 mm (2.23 in) maximum
Depth:	279.4 mm (11.00 in) maximum
Width:	190.0 mm (7.48 in) maximum
Weight:	2 kg (4.4 lbs) maximum
Material and Finish:	Conversion coated aluminium
Connectors:	Four 50 pin D-Sub, two male and two female Jack post locking hardware
Installation:	RS-422 Cable: 20.0 m (785.9 in) maximum RM01 Cable: 0.3 m (11.8 in) maximum MIC Cable: 5.0 m (196.7 in) maximum PHN Cable: 5.0 m (196.7 in) maximum USB Cable: See USB 2.0 Specification
Mounting:	Bulkhead Mount: Four 10-32 screws

1.4.3 Environmental Specifications

The AMU50-001 has been tested to the environmental conditions listed below. Environmental categories for which TSO and ETSO compliance has been demonstrated are listed on the Environmental Qualification Form in Section 2 of this manual.

Temperature:	-40 to +70° C (Operating) -45 and +85° C (Short Time Operating) -55 to +85° C (Ground survival)
Altitude:	50,000 feet max
Humidity:	95% non-condensing
Shock:	Operational Shock; 6 g for 11 ms Crash Safety (impulse); 20 g for 11 ms Crash Safety (sustained); 20 g for 3 s
Vibration:	RTCA/DO-160E category [(SBM)(U2FF1)]

1.4.4 Product Approval

1.4.4.1 FAA: TSO-C139

When configured as defined in section 1.4.5 (DACS System Equipment) the Digital Audio Communication System is approved as follows:

FAA: TSO-C139 (RTCA/DO-214 Class Ib, RTCA/DO-160E, RTCA/DO-178B Level C)



AMU50-001 Audio Management Unit SM76 Installation and Operation Manual

1.4.4.2 EASA: ETSO-C50c

When configured as defined in section 1.4.5 (DACS System Equipment) the Digital Audio Communication System, with an AMU50-xxx which has MOD 15 incorporated, is approved as follows:

EASA: ETSO-C50c (RTCA/DO-214 Class Ib, RTCA/DO-160E, RTCA/DO-178B level C)

When configured as defined in section 1.4.5 (DACS System Equipment) the Digital Audio Communication System, with an AMU50-xxx which does not have MOD 15 incorporated, is approved as follows:

EASA: ETSO-C50c (RTCA/DO-214 Class Ib, RTCA/DO-160E, RTCA/DO-178B level D)

1.4.5 DACS System Equipment

Product approvals listed in section 1.4.4 apply only to DACS systems configured using approved components as shown below.

1.4.5.1 Required Equipment

System Component	Approved Part No.	MOD
Audio Management Unit	AMU50-xxx	MOD 12 and above (Serial No 3000 and above)
Audio Control Panel (ACP 1 and ACP 2)	ACP53-xxx	MOD 8 and above (Serial No 3000 and above)
	ACP54-xxx	MOD 2 and above (Serial No 3000 and above)

1.4.5.2 Optional Equipment

System Component	Approved Part No.	MOD
Audio Control Panel (ACP 3 to ACP 6)	ACP51-xxx	MOD 2 and above (Serial No 3000 and above)
	ACP53-xxx	MOD 8 and above (Serial No 3000 and above)
	ACP54-xxx	MOD 2 and above (Serial No 3000 and above)
Remote Memory	RM01-xxx	MOD 3 and above (Serial No 3000 and above)

Installation instructions for the Audio Control Panels and Remote Memory are available in the following manuals: SM75 (ACP53-xxx), SM77 (RM01-xxx), SM81 (ACP51-xxx), SM82 (ACP54-xxx).

Refer to section 2.4.2 Cautions (Installation Limitations) for details of configuration settings required for TSO-C139 and ETSO-C50c compliance.

Section 1 ends



AMU50-001 Audio Management Unit SM76 Installation and Operation Manual

Section 2 Installation

2.1 Introduction

Information in this section consists of unpacking and inspection procedures, installation procedures, post-installation checks and installation drawings for the AMU50-001 Audio Management Unit (AMU50).

Review all notes, warnings and cautions.

2.2 Unpacking and Inspection

Unpack the equipment carefully and locate the warranty card. Inspect the unit visually for damage due to shipping and report all such claims immediately to the carrier involved. Check that all items listed below are present before proceeding and report any shortage immediately to your supplier:

- Warranty Card
- Certificate of Conformity or Release Certification

2.2.1 Warranty

All Northern Airborne Technology Ltd. products are warranted for 2 years from date of installation by an authorized dealer, to be free of defects in workmanship or performance. This warranty covers all materials and labour, but is exclusive of any transport to deliver the defective unit to and from Northern Airborne Technology or its designated warranty repair center, or any labour to remove or re-install the defective unit in the aircraft. Contact Northern Airborne Technology for any questions regarding this warranty, its applicability to your units and/or for return authorization. Northern Airborne Technology is the final arbitrator concerning warranty administration. Units which have been physically damaged, burned, immersed in water or otherwise abused beyond the scope of normal use will not be considered for warranty. **WARRANTY IS VOID UNLESS THE PRODUCT IS INSTALLED BY AN AUTHORIZED Northern Airborne Technology DEALER.** Product for which a warranty card is not returned shall be warranted from date of manufacture.

2.3 Continued Airworthiness

Maintenance of the AMU50-001 Audio Management Unit is 'on condition' only. Periodic maintenance of this product is not required.

2.4 Installation Procedures

2.4.1 Warnings

WARNING:
High volume settings can cause hearing damage.
Set the headset volume control to the minimum volume setting prior to conducting tests, and slowly increase the headset volume to a comfortable listening level.



**AMU50-001 Audio Management Unit
SM76 Installation and Operation Manual**

2.4.2 Cautions

CAUTION:

Do not bundle any lines from this unit with transmitter coax feed lines. Do not bundle any logic, audio, or DC power lines from this unit with 400 Hz synchro wiring or AC power lines. Do not position this unit next to any device with a strong alternating magnetic field such as an inverter, motor or blower, or significant audio interference will result.

CAUTION:

In all installations, use shielded cable exactly as shown, and ground only as indicated. Significant problems may result from not following these guidelines.

Failure to follow the installation and wiring instructions provided in this manual for power and ground connections, including the rating of the circuit breaker, may lead to damage in the power input circuitry of the unit.

CAUTION:

Installation Limitations

1. Mounting

The AMU50 must be mounted to an aluminium surface at least 376mm x 333mm x 1.27mm thick (14.8" x 13.1" x 0.050" thick) or equivalent for proper heat dissipation. Failure to do this may mean that the unit will not meet its minimum performance standard requirements at the operating high temperature defined in the environmental qualification form.

2. Approved Configurations

The DACS has only been tested to demonstrate compliance with the requirements of TSO-C139 and ETSO C50c with the configuration settings listed below. Settings other than those listed are not approved.

DevCs Explorer Panel Item	Data Edit Panel Parameter		Selection
AMU50	ICS Tie Line		Analog
Users (User 1 to User 7)	Mic/Headphone:	MIC Impedance	150 Ohm
		Phone Impedance	150 Ohm
Emergency Mode	User 1 and 2:	MIC Impedance	150 Ohm
		Phone Impedance	150 Ohm

These settings are selected through the DevCs (NAT P/N: 79-04-001 Revision 1.5.0.0 or later).



AMU50-001 Audio Management Unit SM76 Installation and Operation Manual

CAUTION:

DACS LRU Replacement

If a replacement RM01 is being installed, it is important to be aware that the configuration data from the existing AMU50 will be overwritten by factory default data stored in the RM01. Similarly, if a replacement AMU50 is being installed, the configuration data in the AMU50 will be overwritten by the data stored in the existing RM01 (if installed).

Refer to the Northern Airborne Technology DevCs Installation and Operation manual for information on re-entering configuration data for a DACS AMU50 Audio Management Unit.

CAUTION:

The AMU50 will start up in Maintenance Mode if the Weight On Wheels input is grounded and the USB port is active when power is applied to the unit.

2.4.3 Mounting

The AMU50 can be bulkhead mounted in any orientation using four 10-32 screws. No shock or vibration isolators are required.

The AMU50 must be mounted to a clean metal surface which is electrically bonded to the aircraft ground plane. The unit is finished with a coating which prevents corrosion. This film is electrically conductive and should not be removed for electrical bonding.

2.4.4 Cabling and Wiring

All wire shall be selected in accordance with the original aircraft manufacturer's Maintenance Instructions or AC43.13-1B Change 1, Paragraphs 11-76 through 11-78. Unshielded wire types shall qualify to MIL-W-22759 as specified in AC43.13-1B Change 1, Paragraphs 11-85, 11-86, and listed in Table 11-11. For shielded wire applications, use Tefzel MIL-C-27500 shielded wire with solder sleeves (for shield terminations) to make the most compact and easily terminated interconnect. Follow the connector map in Section 2.7 as required.

Allow 3" from the end of the shielded wiring to the shield termination to allow the connector hood to be easily installed. Reference the interconnect drawing in Section 2.7 for shield termination details. Note that the hood is a "clamshell" hood, and is installed after the wiring is complete.

Maintain wire segregation and route wiring in accordance with the original aircraft manufacturers Maintenance Instructions.

Unless otherwise noted, all wiring shall be a minimum of 22 AWG, except power, headphones, mic and ACP power lines, which shall be a minimum of 20 AWG. Reference the Interconnect drawing for additional specifications. Check that the ground connection is clean and well secured, and that it shares no path with any electrically noisy aircraft accessories such as blowers, turn and bank instruments or similar loads. Power to this unit must be supplied from a separate circuit breaker or fuse (fast blow), and not attached to any other circuit breaker without additional protection. Verify that the selected circuit breaker size and wire gauge are adequate for the installation using the techniques specified in AC43.13-1B Change 1, Paragraphs 11-47 through 11-51 and 11-66 through 11-69.



AMU50-001 Audio Management Unit SM76 Installation and Operation Manual

2.4.4.1 Interconnect References

The Interconnect (AMU50\001\403-0) and Connector Map (AMU50\001\405-0) show standard signal designations. For information on the correlation between these designations and the Transmit/Receive signal designations for a specific ACP, refer to the Custom Designation Cross-Reference List (ACP5\xxx\724-1) in the Installation and Operation section of the relevant ACP Service Manual.

2.4.4.2 NORM and EMERG Power Inputs

The NORM power input is active when the system is in NORM mode. The EMERG power input is active when the system is in BK-UP or EMERG modes. If 28 Vdc power is lost on both NORM and EMERG power inputs then no audio is provided to any user. **If audio is required by users 1 and 2 during emergency electrical system conditions, the EMERG power input must be connected to an aircraft essential 28 Vdc buss or battery buss.**

2.4.4.3 Normal and Backup Mode Inputs

There are two NORM MODE inputs (ACP1 and ACP2) on the AMU50 (one for User 1 and one for User 2). When both of these inputs are active, the system will be in Normal Mode.

There are two BACKUP MODE inputs (ACP1 and ACP2) on the AMU50 (one for User 1 and one for the User 2). When either of these inputs is active, the system will enter Backup Mode.

When the system is in Backup Mode, users 1 and 2 maintain full functionality via backup microphone and headphone amplifiers but all other headsets and ACPs are disabled. This mode is to overcome a crew headset amplifier failure or a failure of circuitry used to support passengers that may be adversely affecting the operation of the system.

When User 1 or User 2's Normal Mode and Backup Mode inputs become inactive the AMU50 will enter Emergency Mode.

In Emergency Mode, all ACPs are deactivated. User 1 and User 2 maintain a limited amount of functionality however. In this mode, User 1 will be able to listen to COM1, NAV1, Direct1, Direct2, Direct3 and all alerts at a fixed level. User 1 will be able to transmit on COM1. In this mode, User 2 will be able to listen to COM2, NAV2, Direct1, Direct2, Direct3 and all alerts at a fixed level. User 2 will be able to transmit on COM2. User 1 and User 2 will have keyed intercom audio at a fixed level.

Emergency Mode disables the Digital Signal Processing software and provides the above functionality using analog technology.

2.4.4.4 Routing of Power Lines

RTCA/DO-160E Section 22 Lightning Induced Transient Susceptibility testing of the AMU50 cable bundles was conducted with the 28 Vdc power lines bundled with the control/signal leads. To maintain the equipment lightning protection, the power lines must be bundled with the control/signal lines in the aircraft installation.



AMU50-001 Audio Management Unit SM76 Installation and Operation Manual

2.4.4.5 Aural Alerts

The AMU50 can provide up to eight supplemental aural alerts. Each aural alert consists of one or two audio data files which are played consecutively. The priority, repetition, activation, enabled output, audio level and audio data files for each Aural Alert can be configured using the DevCs application.

CAUTION:

These alerts must not be used for primary aircraft warnings; audio for primary aircraft warnings should be generated externally to the AMU50 and connected to the AMU50 direct audio inputs.

CAUTION:

Ensure that at least one valid WAV file is assigned to each alert that is enabled. When an enabled alert is activated for which no valid WAV file has been assigned, alert audio for all alerts will not be played correctly. The alert playing function will recover when the alert input is de-activated.

CAUTION:

Do not assign the alert priority as "Highest (4)" for more than six alerts. If more than six alerts with priority assigned as "Highest (4)" are activated simultaneously, the system will not respond to ACP control inputs; audio will continue to play corresponding to the last control settings. The system can be selected to EMER mode using a Mode Control switch to permit emergency mode functionality, or full system control can be re-established by reducing the number of active alert inputs to six or below and de-selecting, then re-selecting NORM mode using the ACP Mode Control switch.

2.4.4.6 Interconnect Inputs

2.4.4.6.1 Passenger Intercommunication System Volume (PAX VOL+/-)

The AMU50 has two Passenger ICS Volume Inputs for adjusting the ICS Audio Level for all users assigned to the virtual ACP and the digital ICS tieline. The PAX VOL switch (if installed) should be attached to the PAX VOL+ and PAX VOL- pins. Each activation of the PAX VOL switch causes one volume level change of 2 dB: an increase for the positive pin and a decrease for the negative pin. The Passenger power-up ICS Level Variable default value is configured using the DevCs application.

This input is operational with the AMU50 configured in Normal mode only.

2.4.4.6.2 Normal Call Input (NORM CALL IN)

When in ISO mode, if the Normal Call Input is activated, the AMU50 causes the call indicators on all ACPs to flash, and sends a Normal Call tone to all headsets. The level of the Normal Call tone is configured for each ACP using the DevCs application.

This input is operational with the AMU50 configured in Normal mode only.



AMU50-001 Audio Management Unit SM76 Installation and Operation Manual

2.4.4.6.3 High Priority Call Input (HIGH PRIORITY CALL IN)

When in ISO mode, if the High Priority Call Input is activated, the AMU50 causes the call indicators on all ACPs to flash at a higher rate, and sends a High Priority Call tone to all headsets. The level of the High Priority Call tone is configured for each ACP using the DevCs application.

This input is operational with the AMU50 configured in Normal mode only.

2.4.4.6.4 Isolation Override Input (ISOLATION OVERRIDE IN)

When in ISO mode, if the Isolation Override Input is activated, the AMU50 temporarily deactivates ISO mode so that the cabin members can talk to the crew. The level of the ICS heard during ISO override is configured for each ACP using the DevCs application.

This input is operational with the AMU50 configured in Normal mode only.

2.4.4.6.5 Alert Inputs (ALERT 1 thru ALERT 8)

The AMU50 supports eight discrete Aural Alert inputs; each can be configured for Active Hi or Active Lo triggering. The configured logic (active Hi or active Lo triggered) for each Aural Alert is configured using the DevCs application.

This input is operational with the AMU50 configured in all modes.

2.4.4.6.6 Aural Alert Inhibit (ALERT INHIBIT)

When the Aural Alert Inhibit input is activated, the AMU50 will mute all active Aural Alert messages. New aural alerts that become active while the Aural Alert Inhibit input is active will be muted. Deactivating the Aural Alert Inhibit input will cause any aural alerts that are still active to play.

This input is operational with the AMU50 configured in all modes.

2.4.4.6.7 Aural Alert Cancel (ALERT CANCEL)

If a cancellable alert is playing, activating the Aural Alert Cancel input will cancel the alert, even if the trigger condition still exists. Even if the alert is cancellable, an alert will be played at least once before the cancellation will take effect. A new cancellable alert triggered after the Aural Alert Cancel input is activated will be unaffected. The DevCs application may be used to configure any Aural Alert generated by the AMU50 as 'cancellable' or 'not cancellable'.

This input is operational with the AMU50 configured in all modes.

2.4.4.6.8 Weight On Wheels Input (WEIGHT ON WHEELS)

The Weight On Wheels input must be open circuit when the aircraft is in flight.

CAUTION:

The AMU50 will start up in Maintenance Mode if the Weight On Wheels input is grounded and the USB port is active when power is applied to the unit. The AMU50 must not be operated in maintenance mode during flight.



AMU50-001 Audio Management Unit SM76 Installation and Operation Manual

The AMU50 will communicate with the RM01 to verify and download configuration data from the RM01 if the Weight On Wheels input is grounded when power is applied to the unit, or the AMU50 mode is changed using the ACP Mode Control switch. If the Weight On Wheels input is not grounded, the AMU50 will use internally stored configuration data. This is intended to minimise start up delay if power to the AMU50 is cycled in flight, or if the AMU50 mode is changed using the ACP Mode Control switch.

This input is operational with the AMU50 configured in all modes.

2.4.4.6.9 Winchman Select (ACP 1 WINCHMAN SELECT thru ACP 3 WINCHMAN SELECT)

The winchman position is User 7. By using an external 4-position rotary switch to ground one of the Winchman Select pins (J101 pin 46 or 48, J102 pin 46), the winchman position can be associated with ACP 1, 2 or 3 and will adopt all the features associated with that ACP. If no winchman input is active, or more than one winchman input is active, the winchman returns to the pre-programmed ACP assignment.

This input is operational with the AMU50 configured in Normal mode only.

2.4.4.7 Interconnect Outputs

2.4.4.7.1 Aural Alert Active output (ALERT ACTIVE)

The Aural Alert Active output becomes active when any of the Aural Alert messages are being played. (This includes the delay between alert repetitions, and between overlapping alert messages).

This output is operational with the AMU50 configured in all modes.

2.4.4.7.2 DF Blanking Output

The DF Blanking output is operational in Normal and Backup Modes, and becomes active when any TX PTT output is active, with a maximum delay of 1 ms.

This output is operational with the AMU50 configured in Normal and Backup modes only.

2.4.4.7.3 Emergency Mode Active Output (EMERG/BACKUP OUT)

The Emergency/Backup Active output becomes active when the system is in Emergency Mode or Backup Mode.

This output is operational with the AMU50 configured in Backup and Emergency modes only.

2.4.4.7.4 Crew Isolation output (CREW ISO OUT)

The Crew Isolation output becomes active and stays active while the crew members are isolated from the passengers. While the isolation mode is temporarily deactivated because of an Isolation Override Call, the Crew Isolation Output is also deactivated.

This output is operational with the AMU50 configured in Normal mode only.



AMU50-001 Audio Management Unit SM76 Installation and Operation Manual

2.4.4.8 Interconnect Audio

2.4.4.8.1 Receive Audio Inputs

The Receive Audio levels and access to Receive Audio inputs from ACPs are configured using the DevCs application.

These inputs are fully operational with the AMU50 configured in Normal and Backup modes. Only transceivers 1 and 2 and receivers 1 and 2 are operational in Emergency mode.

2.4.4.8.2 Direct Audio Inputs (DIR 1 RX thru DIR 6 RX)

The Direct Audio Inputs should be used for aircraft audio warnings. The Direct Audio levels and which user headsets include Direct Audio are configured using the DevCs application. If the ICS tie line is set to analog, the Direct 6 audio input is disabled.

These inputs are fully operational with the AMU50 configured in Normal and Backup modes. Only Direct Inputs 1, 2 and 3 are operational in Emergency mode.

2.4.4.8.3 Composite Audio output

The Composite Audio output (with two preset levels) is a summation of selected audio inputs. It is configured using the DevCs application.

This output is operational with the AMU50 configured in Normal and Backup modes only.

2.4.4.8.4 ICS Tieline

The AMU50 can support ICS communications with an external device on either an analog tieline or a digital tieline, but not both. The analog/digital setting is configured using the DevCs application.

When the tieline is configured as analog, the tieline loading must be equivalent to 1000 Ohms. The tieline must be set to ANALOG mode when connecting multiple AMU50 units together. See the Interconnect in section 2.7 for example loading connections.

This output is operational with the AMU50 configured in Normal and Backup modes only.

2.4.4.8.5 Music Inputs (MUSIC RIGHT/LEFT RX)

The preset music input audio gain level, and the ability for each user to access music, is configured using the DevCs application.

These inputs are operational with the AMU50 configured in Normal or Back-up modes only.

2.4.4.8.6 Cockpit Voice Recorder Outputs (CVR1/CVR2)

The CVR1 output consists of Phones and continuous live mic Audio from User 1. The CVR2 output consists of Phones and continuous live mic Audio from User 2.

These outputs are operational with the AMU50 configured in all modes.



AMU50-001 Audio Management Unit SM76 Installation and Operation Manual

2.4.4.9 Universal Serial Bus (USB)

The AMU50 has one USB 2.0 port which is used for uploading and downloading configuration settings using the DevCs. The port is only for use during maintenance and must not be connected during flight.

2.4.5 Post Installation Checks

2.4.5.1 Voltage/Resistance Checks

Do not attach the AMU50-001 until the following conditions are met.

Check connector **P101** for the following:

- Pins <38> <39> <40> and <41> for continuity to ground (less than 0.5Ω) when the relevant switches are closed.
- Either pin <9> or <10> for continuity to ground (less than 0.5Ω) when the relevant switch is closed.
- Either pin <46> or <48> (ACP 1 or 3 winchman select) for continuity to ground (less than 0.5Ω) if installed.

Check connector **P102** for the following:

- Pins <38> <39> and <40> for continuity to ground (less than 0.5Ω) when the relevant switches are closed.
- Pin <46> (ACP 2 winchman select) for continuity to ground (less than 0.5Ω) if installed.

Check connector **P103** for the following:

- Pin <16> (Norm +28 VDC power) for +28 Vdc relative to ground.
- Pin <17> (Norm power ground) for continuity to ground (less than 0.5Ω).
- Pins <43> <44> <45> and <46> (ICS) for continuity to ground (less than 0.5Ω) when the relevant switches are closed.
- Pin <34> for chassis ground.
- Pins <47> <48> <49> and <50> (Alerts) for proper connection and operation as per the applicable aircraft installation requirements.
Note: Alerts are configurable as either HI or LO and can be used for various supplemental warning operations.
- Pins <31> <14> and <15> for continuity to ground (less than 0.5Ω) when the relevant switches are closed.

Check connector **P104** for the following:

- Pin <16> (Emerg +28 VDC power) for +28 Vdc relative to ground.
Note: This pin must be connected to BACK-UP 28 Vdc power (the Essential/Emer DC Power Buss).
- Pin <17> (Emerg power ground) for continuity to ground (less than 0.5Ω).
- Pin <34> (Chassis ground) for continuity to ground (less than 0.5Ω).



AMU50-001 Audio Management Unit SM76 Installation and Operation Manual

- d) Pins <43> <44> and <45> (ICS) for continuity to ground (less than 0.5Ω) when the relevant switches are closed.
- e) Pins <47> <48> <49> and <50> (Alerts) for proper connection and operation as per the applicable aircraft installation requirements.
Note: Alerts are configurable as either HI or LO and can be used for various supplemental warning operations.
- f) Pins <31> <14> and <15> for continuity to ground (less than 0.5Ω) when the relevant switches are closed.

2.4.5.2 Power On Checks

Power up the aircraft's systems and confirm normal operation of all functions of the system. For a Northern Airborne Technology DACS system, refer to Section 3 of this manual, and to the Operation section of the applicable audio control panel manual for specific operational details. To verify proper operation, all functions and levels shall be checked in-flight.

Upon satisfactory completion of all performance checks, make all required log book entries, electrical load, weight and balance amendments and other documentation as required by your local regulatory agency before releasing the aircraft for service.

2.5 Adjustments and Configuration

2.5.1 Maintenance Mode

The AMU50 has no external adjustments. All modifications to the configuration settings of the AMU50 are made in maintenance mode via the USB port using a computer running the Device Configuration Software (DevCs) application. Refer to sections 2.4.4.6.8 (Weight On Wheels Input) and 2.4.4.9 (Universal Serial Bus) for additional information.

Connect a USB cable from the AMU50 USB port on the aircraft to the USB port on the PC running the DevCs. Cycle the 28 Vdc power to the AMU50 to initiate a restart. The AMU50 will start up in maintenance mode, which allows configuration settings to be adjusted when the following conditions are satisfied:

1. The AMU50 detects a connection to its USB port.
2. Weight-on-wheels input is true (pin 31 of J103 is grounded.)

The configuration for the AMU50 can be changed as required using the DevCs. For full information, consult the DevCs manual.

Note: When new configuration data is written to the AMU50 using the Program AMU50 function of the DevCs, the same data should also be written to the RM01 using the Program RM01 function of the DevCs. If the new configuration data is not written to the RM01, then the original RM01 configuration data will overwrite the new configuration data stored in the AMU50 when the AMU50 is restarted in operational mode. This note applies only if an RM01 is installed.



AMU50-001 Audio Management Unit SM76 Installation and Operation Manual

After the configuration settings have been uploaded, the USB connection must be removed and 28 Vdc power to the AMU50 cycled to restart it in the operational mode. All settings that are essential to aircraft operation must be verified by a system test in both normal and emergency modes (e.g. direct audio audible to crew, transmit and receive functions on COM1 and COM2 operate correctly for crew, receive functions on NAV1 and NAV2 operate correctly for crew, required intercom functions operate correctly, etc.).

2.5.2 DevCs Configurable Settings

The configuration settings available through the DevCs are listed below. For full information, refer to the DevCs Installation and Operation manual.

2.5.2.1 AMU50

The software is used to designate which ACPs are included as crew during Isolation mode, selection of call time-out and duration, the type of ICS tie line, and the error messages.

2.5.2.2 ACP Profiles

There are seven ACP Profiles (ACP1 through ACP6 and Virtual ACP), which are configured through the DevCs and loaded into the AMU50. Each ACP profile is configured for Transceiver Access, Transmitter Access, Receiver Access, Direct Audio Access, Direct Audio Levels, ISO CALL Functionality, Auto Receive Levels, Call Tone Levels, Isolation Override, ICS Level, Audio Muting During Transmit (Direct Audios, Radio Audio, ICS), VOX Preset Level, Transceiver Receive Audio Level After ACP Failure, Transceiver Receive Audio Level, Receiver Receive Audio Level After ACP Failure, Receiver Receive Audio Level, ICS Level After ACP Failure, ICS Level, VOX Level After ACP Failure, and Virtual VOX Level.

2.5.2.3 User Profiles

The User Profiles are parameters for each of the seven users which are configured through the DevCs and loaded into the AMU50. Each User Profile consists of ACP Assignment (see 2.5.2.4 below), Music Access, Music Level, Alert Access, Alert Level, Microphone Impedance (selected from a choice of three values), Microphone Gain, Headphone Impedance, VOX Off Delay Time, and Alert Muting During Transmit.

2.5.2.4 ACP Assignment

User 1 must always be assigned to ACP 1, and User 2 must always be assigned to ACP 2. Users 3 to 7 include the ability for each user to be assigned to an ACP or Virtual ACP.

ACP Assignment in a User Profile can be a 'virtual' ACP. The virtual ACP controls which audio sources the user can listen to and at what level. The 'virtual' ACP also controls which radio a user can transmit on, what audio is being muted during transmit, the level of the call tones and the level of the ICS audio when isolation mode is temporarily suspended (ISO Override).

2.5.2.5 Cockpit Voice Recorder

The output volume level can be selected.



AMU50-001 Audio Management Unit SM76 Installation and Operation Manual

2.5.2.6 Passenger Intercom Amplifier

The software is used to select the passenger intercom volume, VOX level, music input level, mic impedance and gain, phone impedance and VOX off time.

2.5.2.7 Composite Output

The composite audio output components and volumes are selected through the DevCs.

2.5.2.8 Transceivers

The transceiver is enabled, and the transmit mic, receive audio and sidetone criteria for each transceiver is selected through the DevCs.

2.5.2.9 Receivers

The receivers, direct inputs and music receiver are enabled, and the associated audio input levels are selected through the DevCs.

2.5.2.10 WAV Files

The WAV files contain the tones, chimes and voice alerts that are played when an alert is activated. WAV files are loaded into the DevCs.

2.5.2.11 Aural Alerts

The aural alerts are enabled, WAV file selected and priorities configured through the DevCs.

2.5.2.12 Emergency Mode

The DevCs is used to set up the emergency mode configurations for Users 1 and 2.

2.5.2.13 Direct Audio Inputs

The direct inputs are enabled, and the associated audio input levels are selected through the DevCs.

2.6 Accessories Required But Not Supplied

Installation kit p/n **AMU50-IKC** is required to complete the installation. The kit consists of the following:

Quantity	Description	Part No
2	D-Sub, MIL Spec., 50 Socket Crimp Housing	20-21-R50
2	D-Sub, MIL Spec., 50 Pin Crimp Housing	20-11-R50
100	MS Crimp Socket	20-26-901
100	MS Crimp Pin	20-26-891
4	Hoods, D-Sub, Metal	20-28-003
4	Tag Ring, Shield Termination	20-30-416



**AMU50-001 Audio Management Unit
SM76 Installation and Operation Manual**

2.7 Installation Drawings

DRAWING	REV.	DESCRIPTION	TYPE
AMU50\001\403-0	1.24	Audio Management Unit	Interconnect (6 sheets)
AMU50\001\405-0	1.00	Audio Management Unit	Connector Map
AMU50\001\521-0	1.00	Audio Management Unit	Environmental Qualification Form
AMU50\001\922-0	1.31	Audio Management Unit	Mechanical Installation

Section 2 ends following the above documents

REVISIONS			
REV	DESCRIPTION	DATE	BY
	FOR PREVIOUS REVISIONS SEE REV 1.23		
1.24	ECR10335 – NOTE 20 MODIFIED.	JAN 11/10	MWS

AMU50-001 INSTALLATION NOTES

NOTES:

1. ALL WIRES SHOULD BE 22 AWG UNLESS OTHERWISE SPECIFIED. ALL UNSHIELDED WIRE SHALL BE SELECTED IN ACCORDANCE WITH AC43.13-1B CHANGE 1, PARAGRAPHS 11-76 THROUGH 11-78. WIRE TYPES SHOULD BE TO MIL-W-22759 AS SPECIFIED IN AC43.13-1B CHANGE 1, PARAGRAPHS 11-85, 11-86 AND LISTED IN TABLE 11-11. ALL SHIELDED WIRE/CABLE SHOULD BE IN ACCORDANCE WITH MIL-C-27500.
2. CABLE LENGTH NOT TO EXCEED 0.7 FT [0.2 M].
3. GROUND ONLY ONE WINCHMAN SELECT LINE TO DETERMINE WHICH ACP WILL CONTROL THE USER 7/WINCHMAN POSITION.
4. CABLE LENGTH NOT TO EXCEED 1 FT [0.3 M].
5. SYSTEM CROSSTALK WILL BE AFFECTED BY STYLE OF HEADSET AND JACK. CHECK SPECIFICATIONS AND SYSTEM REQUIREMENTS BEFORE SELECTING AND INSTALLING SAME. CABLE LENGTH NOT TO EXCEED 16.4 FT [5.0 M].
6. SHIELDS SHOULD BE GROUNDED TO CONNECTOR BACK SHELL (METAL TYPE).
7. PROVIDE SHORT RETURN TO AIRFRAME GROUND.
8. USB AIRFRAME CONNECTOR IS CUSTOMER SUPPLIED AND INSTALLED. TOTAL CABLE LENGTH BETWEEN AMU50 AND COMPUTER NOT TO EXCEED 3.3 FT [1.0 M].
9. CABLE LENGTH NOT TO EXCEED 65.6 FT [20.0 M].
10. CABLE LENGTH NOT TO EXCEED 3.3 FT [1.0 M].
11. OUTPUT IS GROUNDED WHEN FUNCTION IS ACTIVATED, OUTPUT IS ABLE TO SINK 1 Amp MAX.
12. PROVIDES GROUND TO DF RECEIVER WHEN ANY TRANSCIEVER IS KEYED.
13. THE RADIOS DEFINED IN THIS DRAWING ARE AN EXAMPLE OF ONE CONFIGURATION SETUP. USING THE AMU50 CONFIGURATION SOFTWARE EACH RT OR RX INPUT CAN BE CONFIGURED TO A SPECIFIC FUNCTION AS REQUIRED.
14. DIRECT 1, 2 AND 3 ARE MAINTAINED IN EMER MODE. DIRECT 6 IS DISABLED WHEN ANALOG ICS TIE IS ENABLED.
15. CABLE LENGTH NOT TO EXCEED 16.4 FT [5.0 M].
16. WHEN THE ANALOG TIE LINE IS ENABLED, TIE LINE LOADING MUST BE EQUIVALENT TO 1000 OHMS. SEE SHEET 6 FOR EXAMPLES OF LOADING CONNECTIONS.
17. IF ACP2 IS NOT USED, PIN 42 OF J102 SHOULD BE GROUNDED.
18. ONLY ONE TIE LINE SETTING (ANALOG OR DIGITAL) CAN BE SELECTED
19. THE REMOTE MEMORY UNIT (RM01) WILL ONLY UPLOAD CONFIGURATION DATA TO THE AMU50 WHEN THE WEIGHT ON WHEELS (WOW) SWITCH IS ACTIVATED AND THE USB PORT IS NOT CONNECTED TO A LAPTOP PC.
20. THE AMU50 WILL START UP IN MAINTENANCE MODE IF THE WEIGHT ON WHEELS (WOW) SWITCH IS ACTIVATED AND THE USB PORT IS ACTIVE WHEN THE POWER IS APPLIED TO THE AMU50.
21. REFER TO SM76 AMU50-001 INSTALLATION AND OPERATION MANUAL SECTION 2.4.4.2 FOR CONNECTIONS OF 'NORM' AND 'EMERG' POWER INPUTS.

DEFINITIONS:

- N/C: NO CONNECTION. THE PIN IS NOT CONNECTED TO ANYTHING INTERNALLY, AND THEREFORE SHALL HAVE NO CONNECTION EXTERNALLY.
- N/C SPARE: NO CONNECTION INTERNALLY, BUT A SPARE WIRE SHALL BE INSTALLED IN THE WIRE HARNESS.
- RESERVED: MAY BE CONNECTED AND USED IN THE FUTURE. THE CIRCUITRY MAY BE PRESENT OR ADDED TO ACTIVATE THE FUNCTION. THE PIN MAY BE USED FOR TEST PURPOSES. THERE IS NO EXTERNAL CONNECTION.
- RESERVED SPARE: RESERVED, BUT INSTRUCTIONS SHALL BE FOLLOWED TO ACTIVATE THE CIRCUITRY. A SPARE WIRE SHALL BE INSTALLED IN THE WIRE HARNESS.

CONFIDENTIAL AND PROPRIETARY TO NAT LTD.

DESIGNED	KV	 NAT NORTHERN AIRBORNE TECHNOLOGY LTD.				
DRAWN	KV/MWS					
DATE	JUN 26/07	TITLE				
CHECKED	NAT 255	AUDIO MANAGEMENT UNIT				
APPROVED	NAT 114	SIZE	CAGE CODE	PART NO.	REV.	SHEET
		A	3AB01	AMU50-001	1.24	1/6
FILE	403-0.DWG	DWG. TYPE	INTERCONNECT	DWG. NO.	AMU50\001\403-0	

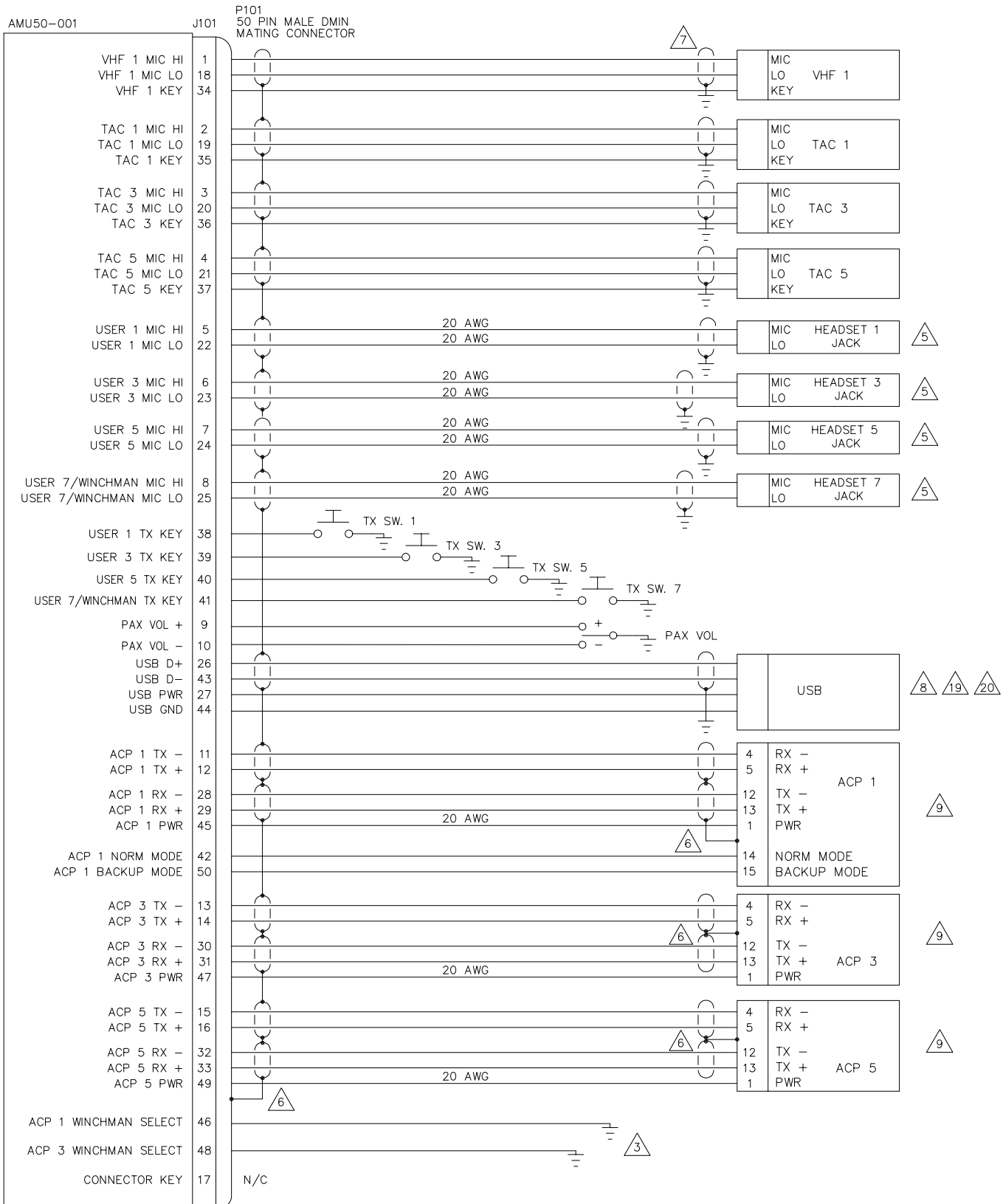

CONFIDENTIAL AND PROPRIETARY TO NAT LTD.

DESIGNED	KV	NAT NORTHERN AIRBORNE TECHNOLOGY LTD.				
DRAWN	KV/MWS					
DATE	JUN 26/07	TITLE				AUDIO MANAGEMENT UNIT
CHECKED	NAT 255					
APPROVED	NAT 114	SIZE	CAGE CODE	PART NO.	REV.	SHEET
		A	3AB01	AMU50-001	1.24	2/6
FILE	403-0.DWG	DWG. TYPE		INTERCONNECT	DWG. NO. AMU50\001\403-1	

AMU50-001

J102

P102
50 PIN MALE DMIN
MATING CONNECTOR

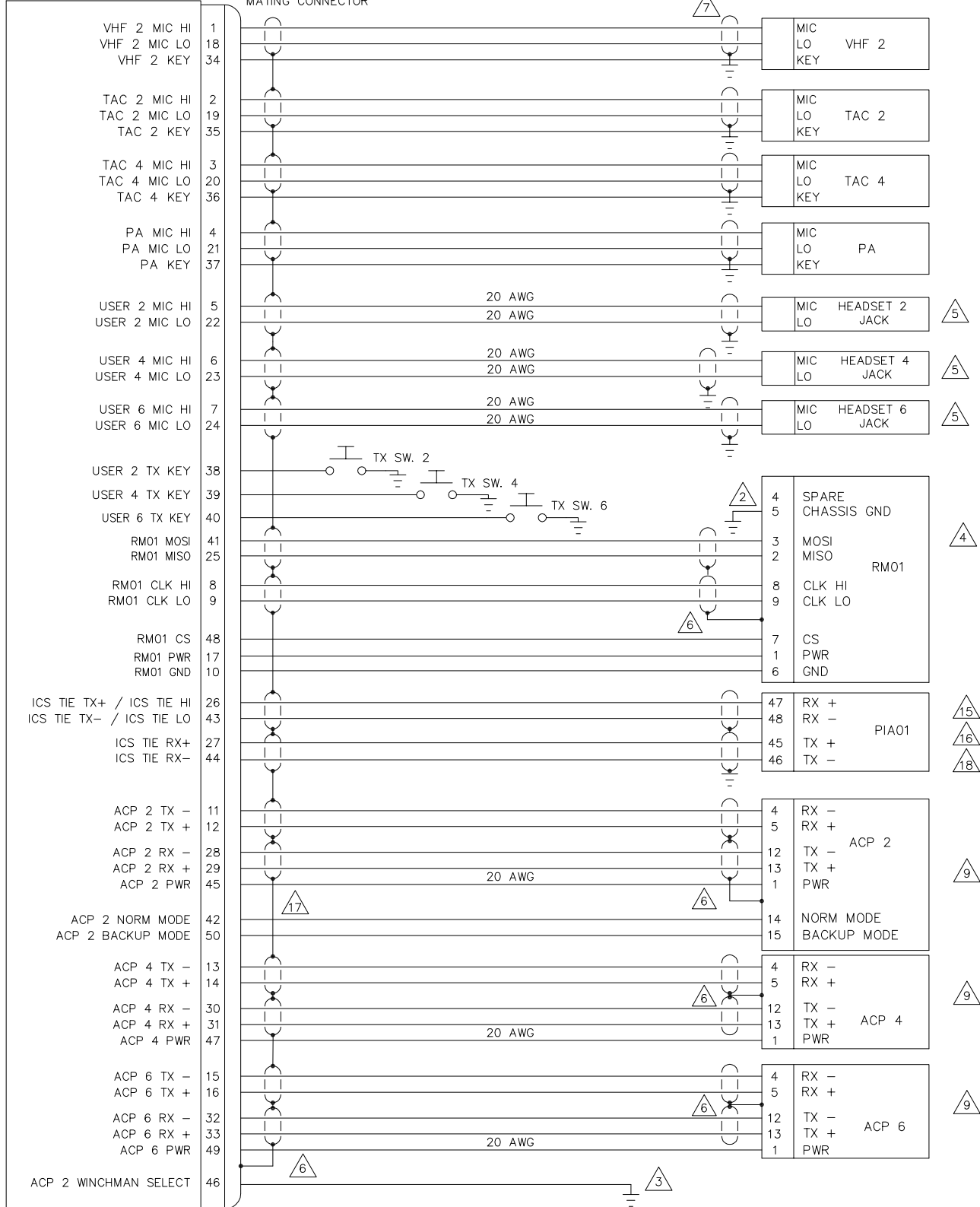

CONFIDENTIAL AND PROPRIETARY TO NAT LTD.

DESIGNED	KV	NAT NORTHERN AIRBORNE TECHNOLOGY LTD.				
DRAWN	KV/MWS					
DATE	JUN 26/07	TITLE AUDIO MANAGEMENT UNIT				
CHECKED	NAT 255					
APPROVED	NAT 114	SIZE	CAGE CODE	PART NO.	REV.	SHEET
FILE	403-0.DWG	A	3AB01	AMU50-001	1.24	3/6
DWG. TYPE		INTERCONNECT		DWG. NO. AMU50\001\403-2		

AMU50-001

J103

P103
50 PIN FEMALE DMIN
MATING CONNECTOR

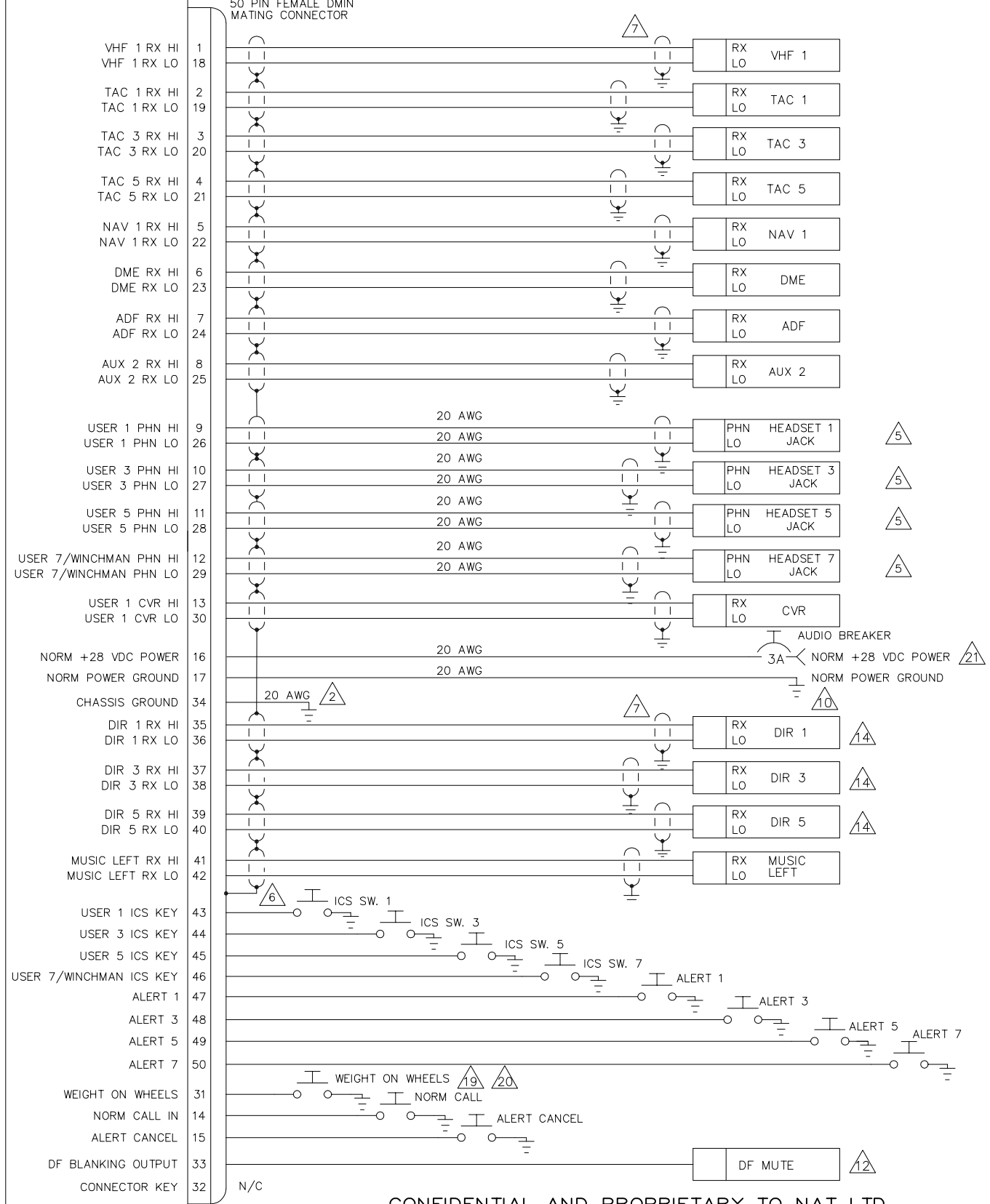

CONFIDENTIAL AND PROPRIETARY TO NAT LTD.

DESIGNED	KV	 NAT NORTHERN AIRBORNE TECHNOLOGY LTD.				
DRAWN	KV/MWS					
DATE	JUN 26/07	TITLE				AUDIO MANAGEMENT UNIT
CHECKED	NAT 255	SIZE	CAGE CODE	PART NO.	REV.	SHEET
APPROVED	NAT 114	A	3AB01	AMU50-001	1.24	4/6
FILE	403-0.DWG	DWG. TYPE	INTERCONNECT	DWG. NO.	AMU50\001\403-3	

AMU50-001

J104 P104
50 PIN FEMALE DMIN
MATING CONNECTOR

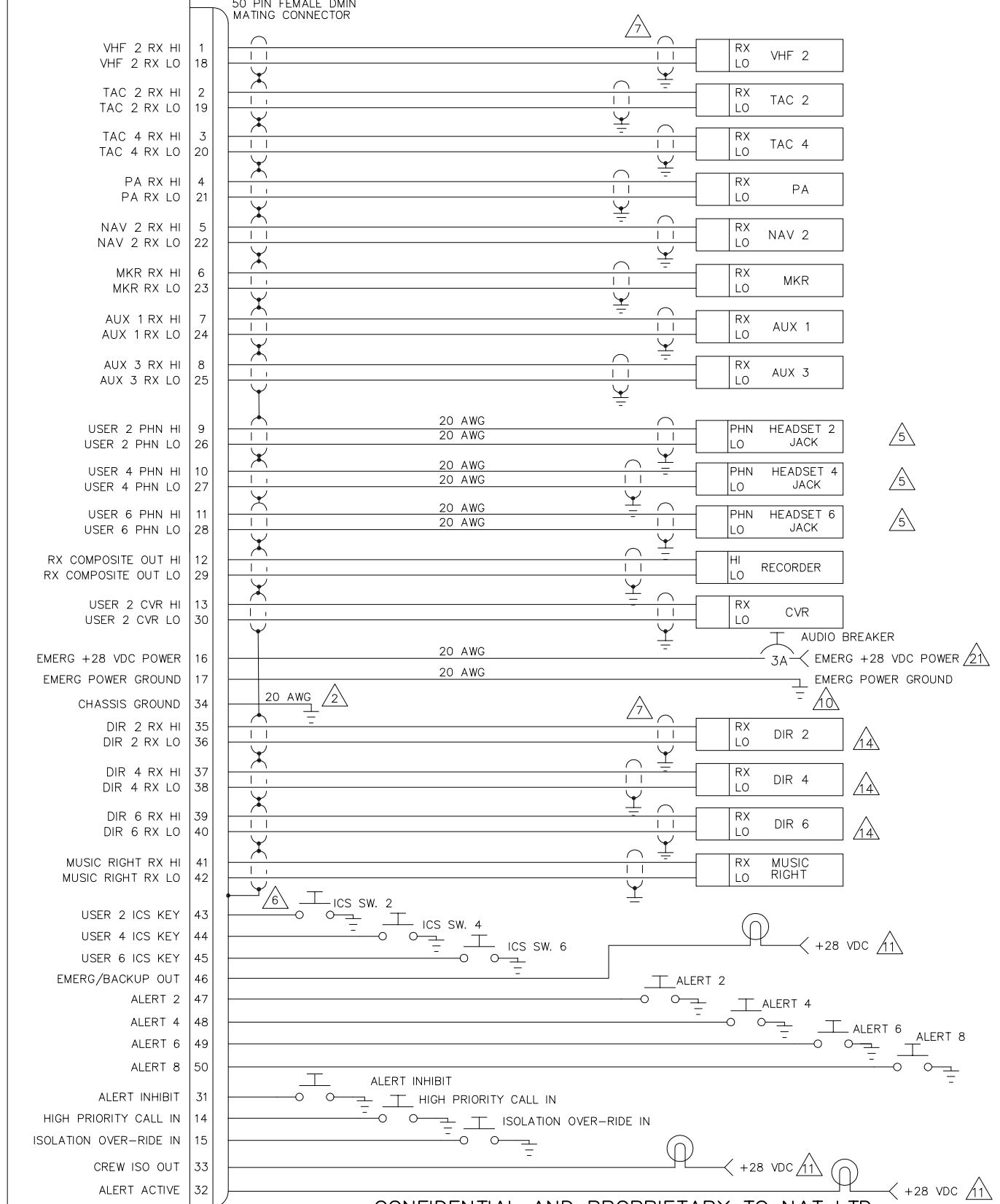

CONFIDENTIAL AND PROPRIETARY TO NAT LTD.

DESIGNED	KV	 NAT NORTHERN AIRBORNE TECHNOLOGY LTD.				
DRAWN	KV/MWS					
DATE	JUN 26/07	TITLE				AUDIO MANAGEMENT UNIT
CHECKED	NAT 255	SIZE	CAGE CODE	PART NO.	REV.	SHEET
APPROVED	NAT 114	A	3AB01	AMU50-001	1.24	5/6
FILE	403-0.DWG	DWG. TYPE	INTERCONNECT	DWG. NO.	AMU50\001\403-4	

OPTION 1

AMU50 CONNECTED TO TWO NAT ANALOG AUDIO PRODUCTS WITH 2k Ohm TIE LINE LOAD.

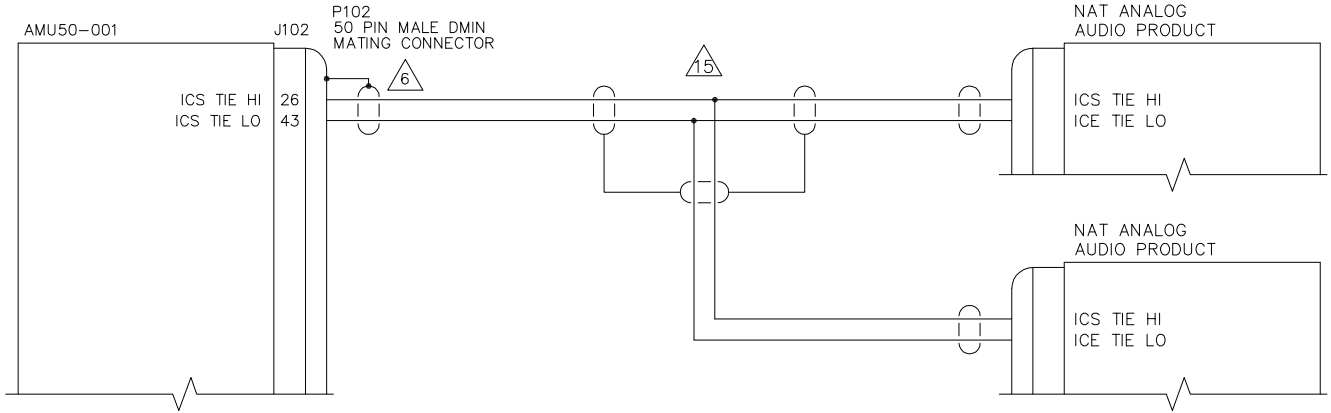

OPTION 2

AMU50 CONNECTED TO ONE NAT ANALOG AUDIO PRODUCTS WITH 2k Ohm TIE LINE LOAD AND ONE 2k Ohm RESISTIVE LOAD.

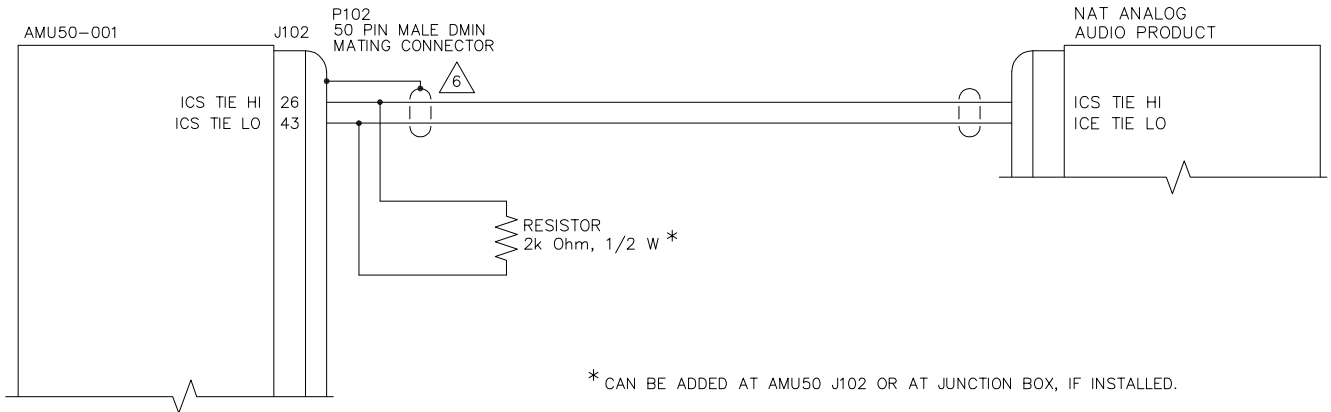

* CAN BE ADDED AT AMU50 J102 OR AT JUNCTION BOX, IF INSTALLED.

OPTION 3

NO NAT ANALOG AUDIO PRODUCT CONNECTED, AMU50 REQUIRES 1k Ohm RESISTIVE LOAD.

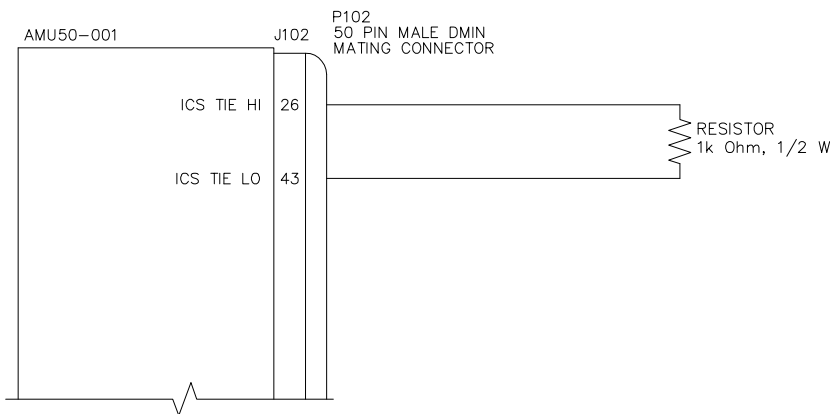

CONFIDENTIAL AND PROPRIETARY TO NAT LTD.

DESIGNED	KV	 NAT NORTHERN AIRBORNE TECHNOLOGY LTD.				
DRAWN	TAT					
DATE	AUG 1/08	TITLE AUDIO MANAGEMENT UNIT				
CHECKED	NAT 255					
APPROVED	NAT 114	SIZE A	CAGE CODE 3AB01	PART NO. AMU50-001	REV. 1.24	SHEET 6/6
FILE	403-0.DWG	DWG. TYPE	INTERCONNECT	DWG. NO.	AMU50\001\403-5	

P101

50 PIN MALE DMIN
MATING CONNECTOR

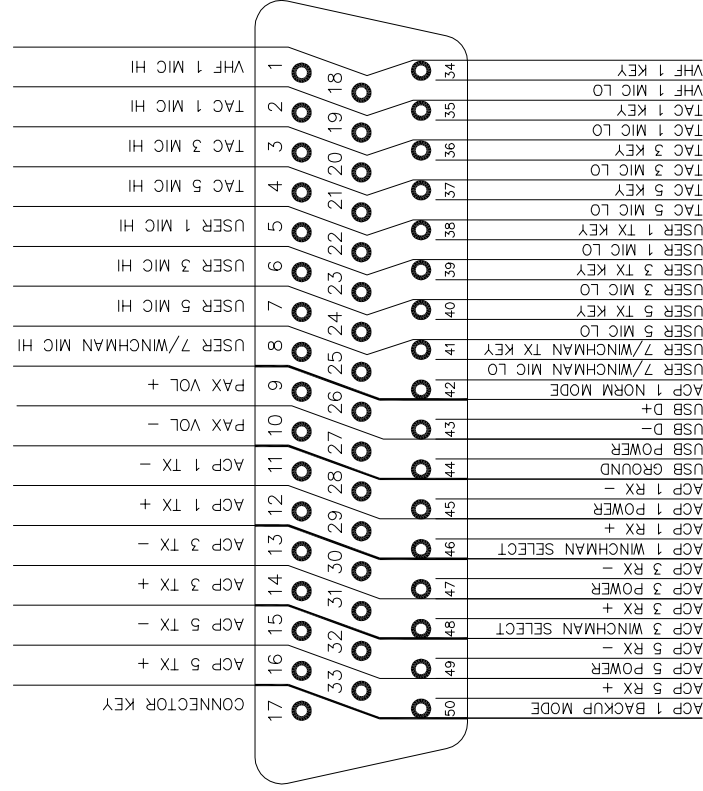

P102

50 PIN MALE DMIN
MATING CONNECTOR

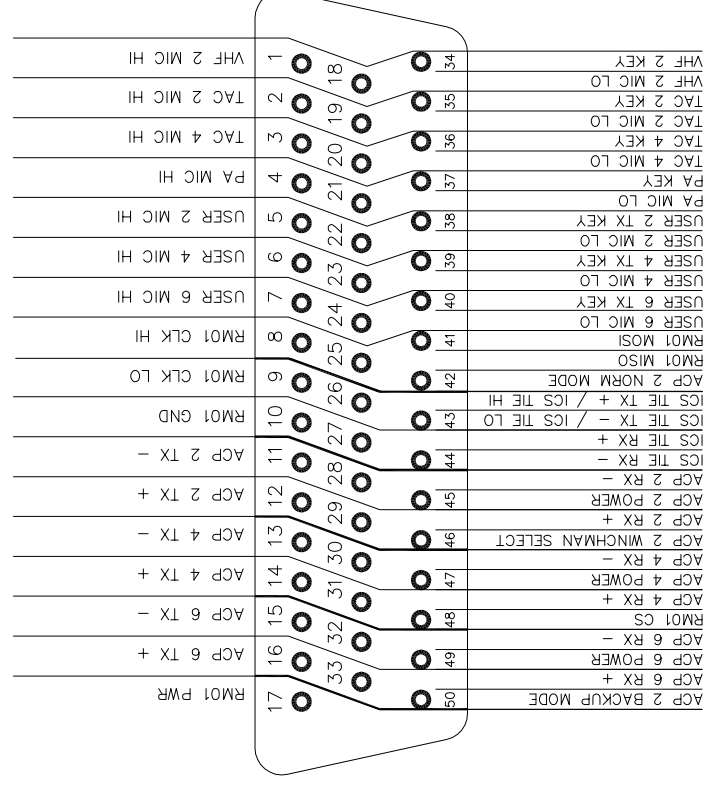

VIEW IS FROM REAR OF AIRFRAME CONNECTOR

P103

50 PIN FEMALE DMIN
MATING CONNECTOR

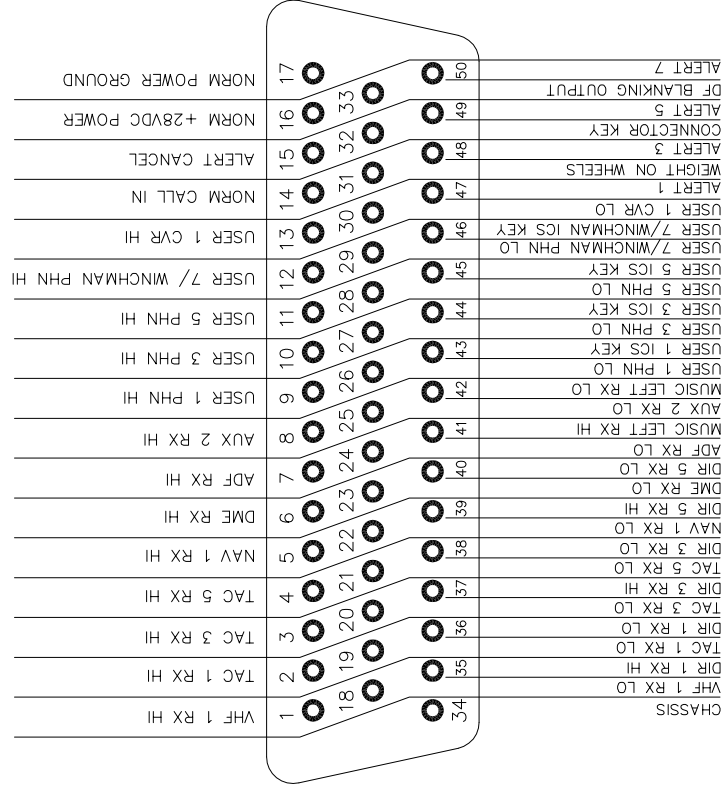

VIEW IS FROM REAR OF AIRFRAME CONNECTOR

P104

50 PIN FEMALE DMIN
MATING CONNECTOR

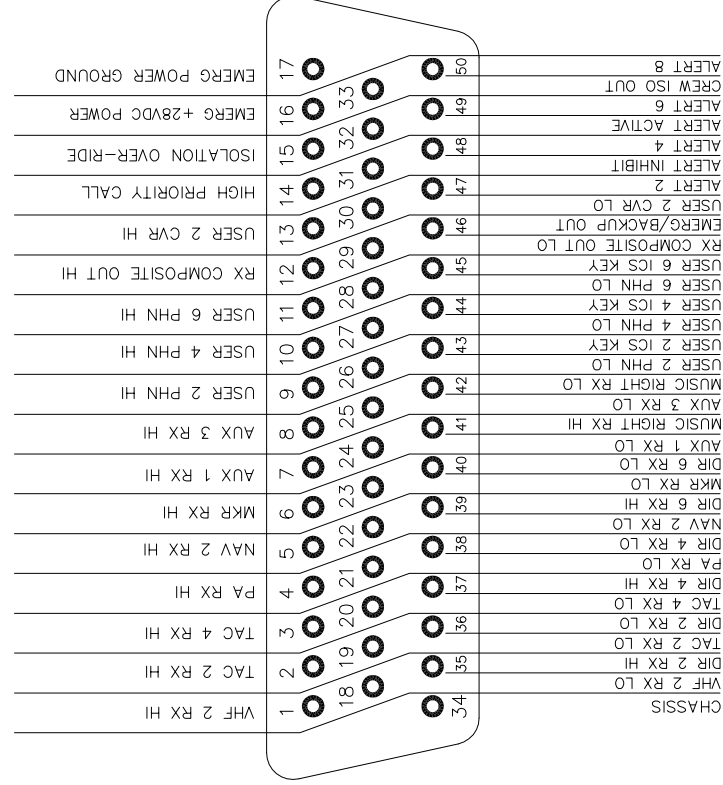

CONFIDENTIAL AND PROPRIETARY TO NAT LTD.

DESIGNED	KV		
DRAWN	KV/MWS		
DATE	JUN 19/07	TITLE	
CHECKED	NAT 249	AUDIO MANAGEMENT UNIT	
APPROVED	NAT 114	SIZE	CAGE CODE
FILE	405-0.DWG	B	3AB01
		PART NO.	AMU50-001
		CONNECTOR MAP	AMU50\001\405-0
		DWG. TYPE	REV. SHEET
			1.00 1/1

nat NORTHERN AIRBORNE TECHNOLOGY LTD.



ENVIRONMENTAL QUALIFICATION FORM

Description: Audio Management Unit Document #: AMU50\001\521-0

NAT Part #: AMU50-001 TSO #: TSO-C139

Manufacturer's Specification and/or Other Applicable Specification: _____

RTCA/DO-160E, RTCA/DO-214

Manufacturer: Northern Airborne Technology Ltd.

Address: 1925 Kirschner Rd., Kelowna, BC, Canada. V1Y 4N7

Prepared By:

DE
05

Checked By:

NAT
200

Approved By:

NAT
149

Conditions	Section	Description of Conducted Tests
Temperature and Altitude	4.0	Category [(A4)(D1)-]
Ground Survival Low Temperature	4.5.1	-55° C
Short-Time Operating Low Temp.	4.5.1	-45° C
Operating Low Temperature	4.5.2	-40° C
Ground Survival High Temperature	4.5.3	+85° C
Short-Time Operating High Temp.	4.5.3	+70° C
Operating High Temperature	4.5.4	+70° C
In-flight Loss of Cooling	4.5.5	N/A. No forced air cooling.
Altitude	4.6.1	+50,000 ft (+15,240 m)
Decompression	4.6.2	+8,000 ft to +50,000 ft (+2,438 m to + 15,240 m)
Overpressure	4.6.3	-15,000 ft (-4,752 m)
Temperature Variation	5.0	Category B.
Humidity	6.0	Category B.
Operational Shocks and Crash Safety	7.0	Category B.
Operational Shocks	7.2.2	Alternate Test Procedure.
Crash Safety	7.3.2	Alternate Test Procedure (Impulse).
	7.3.3	Test Procedure 2 (Sustained), Unknown or Random orientation in aircraft.
Vibration	8.0	Category [(SBM)(U2FF1)] (without shock mounts).

Conditions	Section	Description of Conducted Tests
Explosive Atmosphere	9.0	Category X, no test performed.
Waterproofness	10.0	Category X, no test performed.
Fluids Susceptibility	11.0	Category X, no test performed.
Sand and Dust	12.0	Category X, no test performed.
Fungus	13.0	Category X, no test performed.
Salt Fog	14.0	Category X, no test performed.
Magnetic Effect	15.0	Category Z.
Power input	16.0	Category Z. <ul style="list-style-type: none"> • The system was tested to DO-160E subparagraph 16.6.1.3 b, requirement for equipment with digital circuits. • The system was tested to DO-160E subparagraph 16.6.1.1 b (3) Emergency Operating Voltage conditions. • The system was tested to DO-160E subparagraph 16.6.2.2 Low Voltage Conditions
Voltage Spike	17.0	Category A.
Audio Frequency Susceptibility	18.0	Category Z.
Induced Signal Susceptibility	19.0	Category [ZC].
Radio Frequency Susceptibility	20.0	Category [RR]. <ul style="list-style-type: none"> • DO-160E subparagraph 20.5 Radiated Susceptibility was tested per DO-214 section 2.5.11 and DO-160E.
Radio Frequency Emission	21.0	Category H.
Lightning Induced Transient Susceptibility	22.0	Category [A3J33].



Conditions	Section	Description of Conducted Tests
Lightning Direct Effects test	23.0	Category X, no test performed.
Icing	24.0	Category X, no test performed.
Electrostatic Discharge	25.0	Category X, no test performed.
Fire, Flammability	26.0	Category X, no test performed.
Other Tests		

REMARKS

- DO-160E, Sections 4 to 8, and 15 to 17 tests were conducted at Northern Airborne Technology Ltd. (NAT) in Kelowna, BC on AMU50-001.
- DO-160E, Sections 18 to 22 tests were conducted at CKC Laboratories in Bothell, WA on AMU50-001.
- Testing was conducted with the AMU50-001 configured as part of the Digital Audio Communication System (DACS). Where compliance with Minimum Performance Standards is required by DO-160E it was assessed on the system against DO-214 Section 2.5.
- Testing was performed between June 2008 and March 2009.

End of Environmental Qualification Form

REVISIONS

REV	DESCRIPTION	DATE	BY
1.10	REFER TO DOCCR02205 FOR DETAILS.	AUG 14/07	MWS
1.20	REFER TO DOCCR02475 FOR DETAILS.	APR 14/08	MWS
1.30	DOCCR02623 - ADDED ESD & WARRANTY VOID LABEL.	SEP 05/08	MWS
1.31	DOCCR02888 - CORRECTED TEXT.	NOV 04/09	MWS

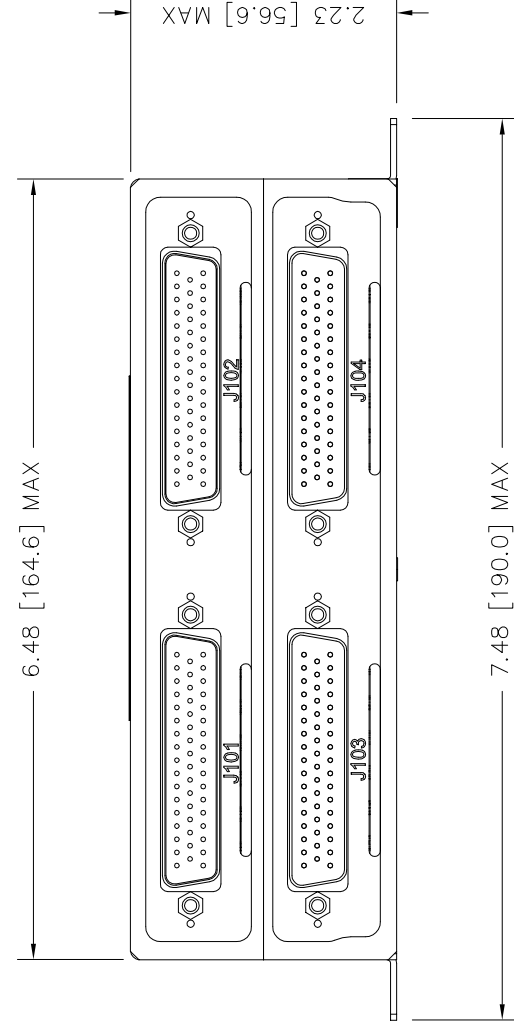
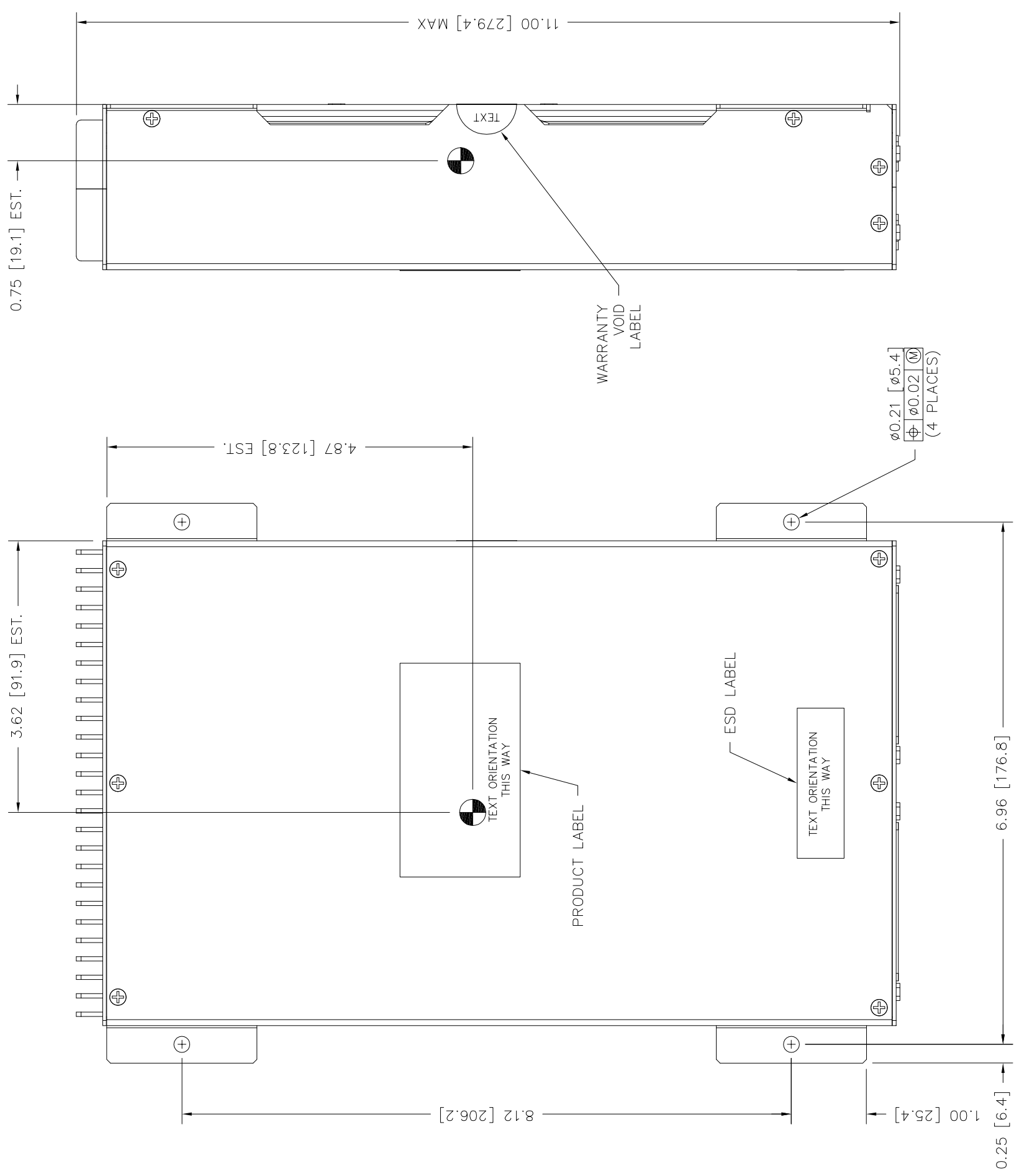

NOTES:
1. DIMENSIONING AND TOLERANCING
IN ACCORDANCE WITH ASME Y14.5M-1994

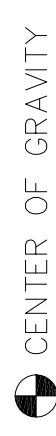

CENTER OF GRAVITY

CONFIDENTIAL AND PROPRIETARY TO NAT LTD.

TOLERANCES UNLESS STATED OTHERWISE	DESIGNED	KV	CONFIDENTIAL AND PROPRIETARY TO NAT LTD.	
0.X=+/-0.030	DRAWN	MWS	nat NORTHERN AIRBORNE TECHNOLOGY LTD.	
0.XX=+/-0.010	DATE	JUN 21/07	TITLE	
0.XXX=+/-0.005	CHECKED	NAT	AUDIO MANAGEMENT UNIT	
0.XXXX=+/-0.002	APPROVED	255	SIZE	CAGE CODE
ANGLE=+/- 0.5 DEG.		NAT 114	B	3AB01
MASS: 4.4 lbs. (2.0 kg) MAX	FILE	922-0.DWG	MECH. TYPE	INSTALLATION
MATERIAL: ALUMINUM	COATING			
FINISH: CONVERSION			DWG. NO.	AMU50\001\922-0
			PART NO.	AMU50-001
			REV.	1.31
			SHEET	1/1



AMU50-001 Audio Management Unit Installation and Operation Manual

Section 3 Operation

3.1 Introduction

Information in this section consists of the functional and operational procedures for the AMU50-001 Audio Management Unit (AMU50).

The AMU50 Audio Management Unit has no operator accessible controls.

If the AMU50 is part of the Northern Airborne Technology Ltd Digital Audio Communications System (DACS), all modifications to the operating parameters are made through the Device Configuration Software (DevCs). For full information, consult the DevCs manual.

The AMU50 controls the functionality of all the components of an aircraft's communications system, including, but not limited to, the Audio Control Panels (ACPs) and external switches. The general functionality of these components is outlined in section 3.3 below.

3.2 General Information

The AMU50 Audio Management Unit is part of the Digital Audio Communication System (DACS), a management system that distributes and controls all of the transceiver, receiver and warning source audio in an aircraft. It enables the transmission of microphone audio to a selected Transceiver and distributes all Inter-Communication System (ICS) audio.

The primary component of the DACS is the AMU50. Connected to this Line Replaceable Unit (LRU) are the user headsets, transceivers, receivers, and the ACPs. The AMU50 also has an audio accessory port that enables the connection of a unit for providing ICS audio in the cabin.

3.3 Control Functionality

The AMU50 can be configured to control the functionality of any ACPs and a variety of external switches and indicators that are connected into the system.

Note: Confirm the specific criteria associated with this installation with your installing agency.

3.3.1 Audio Control Panels

The Audio Control Panels are the operator interface with the AMU and the digital audio communications system. For information on the operation of the ACP, refer to the relevant Installation and Operation Manual (for example SM75, the ACP53-001 Audio Control Panel Service Manual.)

All the operational and functional criteria for ACPs installed in a DACS are controlled by the AMU50 and configured through the DevCs. For full information, consult the DevCs manual.

3.3.2 PTT Keys

The AMU50 supports six TX PTT and seven ICS PTT keys.



AMU50-001 Audio Management Unit Installation and Operation Manual

3.3.3 Transmit Priority

Transmit priority is given to the user who first engages the PTT, and Transmit PTT is given priority over ICS PTT.

3.3.4 Aural Alerts

Note: The Aural Alerts are configured at installation, and cannot be modified, selected, or changed in any way by the operator, or through the ACP. This is included for information purposes only.

Up to eight aural alerts can be configured at installation, and can consist of tones, voice messages or a combination of both, played once only or repeated.

Repeated aural alerts can be configured to repeat for a set number of times (up to 5), or can repeat continuously. Continuous aural alerts will continue to play until the trigger condition has been resolved; otherwise an alert will stop after the set repetition number, and will not play again (unless the trigger condition is resolved AND the alert is reactivated).

If two or more alerts become active at the same time, the priority of the alert (as configured at installation) will decide which alert plays first, or the sequence in which they repeat. If two or more alerts that have been configured as highest priority are triggered at the same time, they will play simultaneously.

User-specific aural alerts are defined at installation. For full information, consult the DevCs manual.

3.3.5 Remote Alert Cancel Switch

CAUTION:

It is important to be aware of all possible implications if the Aural Alert Cancel switch is activated.

At installation, any Aural Alert generated by the AMU50 may be configured as 'cancellable' or 'not cancellable'. A remote Alert Cancel switch may be installed in the aircraft, and if a cancellable alert is playing, this switch can be used to cancel the alert, even if the trigger condition still exists.

Even if the alert is cancellable, an alert will be played at least once before the cancellation takes effect. A new cancellable alerts triggered after the switch is activated will be unaffected.

3.3.6 Remote Alert Inhibit Switch

CAUTION:

When an Aural Alert Inhibit switch is activated, it is important note that no aural notification will be generated by the AMU50 for any alert situation.

A remote Alert Inhibit switch may be installed in the aircraft. This switch acts as a mute switch for the aural alerts generated by the AMU50; it mutes all aural alert tones and/or voice messages to all users.



AMU50-001 Audio Management Unit Installation and Operation Manual

3.3.7 Audio Muting

The AMU50 can be configured to mute Direct, Receive, and/or intercom audio when a user is transmitting on a transceiver. The muting is configured on a per ACP basis using the DevCs.

Intercom, Radio (transceiver and receiver), Direct, and Aural Alert Audio will mute the Music audio. When the action that caused the Music to mute has ended, the Music progressively returns to the previous level.

3.3.8 EMERG/BACKUP Indicator

An output is supplied to allow an external EMERG/BACKUP indicator to be installed. The indicator will illuminate if the AMU50 is in Backup or Emergency mode.

3.3.9 Passenger Intercom

The AMU50 provides an audio accessory serial data port for connecting a passenger intercom device.

The Voice Operated ICS (VOX) level for the passengers not assigned to an ACP53 is set in the DACS DevCs. The highest VOX level threshold acts as the keyed mode of operation and the VOX circuit shall not gate the microphone audio. In this mode the MIC audio can only be gated using the ICS PTT input. When the lowest VOX level is reached, the ICS shall still be gated but shall only require a small signal to open the ICS channel.

3.3.10 Passenger ICS Volume

The AMU50 supports two Passenger ICS Volume Inputs for adjusting the passenger ICS Audio Level.

Activating the positive Passenger ICS Volume Pin increases the volume, and activating the negative Passenger ICS Volume Pin decrease the volume.

The Passenger ICS Level Variable default value is configured using the DevCs application.

3.3.11 Winchman Select

The AMU50 supports three Winchman inputs to allow the winchman to be associated with ACP 1 through ACP 3. If more than one Winchman Input is active, the winchman adopts the pre-programmed ACP assignment.

3.3.12 NORM Call; High Priority Call; ISO Override

Support is provided for a Normal ICS Call input, a High Priority ICS Call input, and an Isolation Override input. These Call inputs are used by passengers without an ACP to call the crew when they have been isolated.

When the Isolation Override input becomes active, the Isolation Mode is temporarily suspended and the passengers can communicate with the crew members.



**AMU50-001 Audio Management Unit
Installation and Operation Manual**

3.3.13 Other Switches and Indicators

Other remote switches and indicators may be installed.

Section 3 ends
