

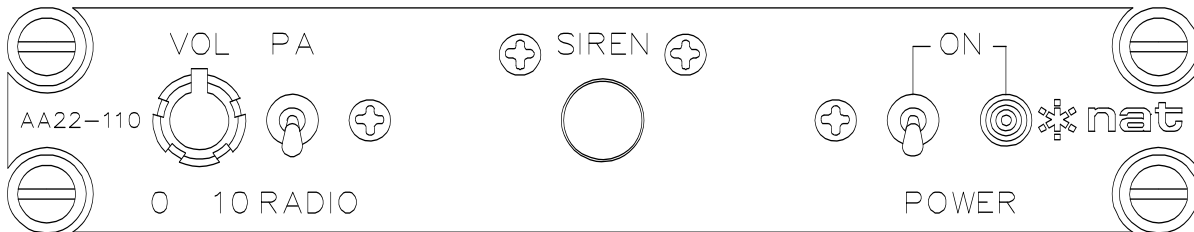

Installation and Operation Manual

AA22 Series PA Driver/Siren Control



SM33-2

ISSUE 4.01

Northern Airborne Technology Ltd.
1925 Kirschner Road
Kelowna, BC, Canada.
V1Y 4N7
Telephone (250) 763-2232
Facsimile (250) 762-3374

Issued on the authority of Northern Airborne Technology Ltd.

Copyright 2008



**AA22 Series PA Driver/Siren Control
SM33-2 Installation and Operation Manual**

IMPORTANT INFORMATION

This manual has been produced to provide information unique to the AA22 Series PA Driver/Siren Control. Some of this information has been published previously in the SM02 Service manual (AA20/22/23 PA110/220 Series Loudhailer / PA systems).

Earlier versions of the AA22 may not be covered by the information in this manual. Please refer to SM02, or contact the Technical Support Department at NAT Ltd.



AA22 Series PA Driver/Siren Control
SM33-2 Installation and Operation Manual

Table of Contents

Section	Title	Page
1.	Description	
1.1	Introduction	1-1
1.2	Product Description	1-1
1.3	Design Features	1-1
1.4	Specifications	1-1
1.4.1	Electrical Specifications	1-1
1.4.2	Physical Specifications	1-2
1.4.3	Environmental Specifications	1-2
1.5	Unit Nomenclature	1-2
2.	Installation	
2.1	Introduction	2-1
2.2	Unpacking and Inspection	2-1
2.2.1	Warranty	2-1
2.3	Continued Airworthiness	2-1
2.4	Installation Procedures	2-2
2.4.1	Warnings	2-2
2.4.2	Cautions	2-2
2.4.3	Cabling and Wiring	2-2
2.4.4	Post Installation Checks	2-3
2.5	Adjustments and Connections	2-4
2.6	Accessories Required But Not Supplied	2-5
2.7	Installation Drawings	2-5
3.	Operation	
3.1	Introduction	3-1
3.2	General Information	3-1
3.3	Controls and Indicators	3-1
3.3.1	Power Up	3-1
3.3.2	Mode Switch	3-1
3.3.3	Volume Control	3-2
3.3.4	Siren Button	3-2
3.3.5	Remote Power Switch	3-2



AA22 Series PA Driver/Siren Control SM33-2 Installation and Operation Manual

Section 1 Description

1.1 Introduction

Information in this section consists of product description, design features and specifications for the AA22 Series PA Driver/Siren Control. All derivative product information shall be contained in the applicable manual supplement, which may be obtained from NAT as required.

Review all notes, warnings and cautions.

1.2 Product Description

The AA22 Series PA Driver/Siren Control is a compact, self-contained, Dzus-mounted unit. The AA22 is a line driver for remote mounted power amplifiers. The AA22-110 or AA22-160 is typically used with the PA110 or PA220, while the AA22-492 or AA22-493 is typically used with the PA250 or PA700.

1.3 Design Features

Microphone interfacing is accomplished from either an AA9x/AMS4x series audio controller, or a 'carbon equivalent' microphone. A radio audio input is provided to allow for radio 'rebroadcast' operation. The siren is adjustable for tone, rate and level. Provision is made for external power switching to activate PA110/220 power amplifiers.

All external connectors, switches and relay contacts are gold plated for maximum reliability. Switches and relays are sealed. G10-FR flame retardant circuit boards are post coated for maximum moisture resistance and corrosion prevention. Relays are sealed, high vibration rated (50g shock) and dry nitrogen filled.

1.4 Specifications

1.4.1 Electrical Specifications

Power	+22 to 32 Vdc (28 Vdc nom) at 250 mA max (excl. lamps). Internally grounded case
Panel Lamps	2 ea. type #387 for 28 Vdc operation Maximum lamp load 80 mA
Inputs	
Mic	0.25 Vrms at 150 Ω
PA and Radio Circuitry	2.5 Vrms at 3.3 Ω Single-ended
Microphone	Industry standard 'carbon equivalent' or amplified dynamic microphone preferred Min. 200 mV output required into 150 Ω David Clark M1/DC, M4, M7 recommended



AA22 Series PA Driver/Siren Control SM33-2 Installation and Operation Manual

Impedance	1 k Ω
Output Circuitry	6 Vrms @ 1 kHz into 600 Ω ground referenced Single-ended
Power Key	Switched +28 Vdc available to activate remote amplifiers
Key Logic	Ground-seeking inputs for all lines

1.4.2 Physical Specifications

Height	1.11" (29.2 mm)
Depth	6.32" (160.5 mm) behind panel, excluding mating connectors
Width	5.75" (146.1 mm) front panel 4.96" (126.0 mm) rear enclosure
Mounting	Standard Dzus Mounting (four fasteners)
Weight	1.00 lbs (0.45 kg) excluding mating connector

1.4.3 Environmental Specifications

Temperature	-20 to +55°C (ambient)
Altitude	25,000 feet max.
Humidity	95%
Shock	12g (any axis)
Qualification	DO-160C Env. Cat. B1-BA[MN]XXXXXXABBBBXXXXX

1.5 Unit Nomenclature

AA22-110	Standard swept siren, adjustable rate/tone Mode select switch, PA/Radio monitor >50 mW output into 150 Ohms 6 Vrms nominal siren output into 600 Ohms 70 mA nominal current consumption PA and Siren override at all times +28 Vdc switched power output Use with PA110 and PA220 series amplifiers
AA22-160	Wail/Yelp swept siren, adjustable rate/tone Mode select switch, PA/Radio monitor 6 Vrms nominal audio output into 600 Ohms 6 Vrms nominal siren output into 600 Ohms 70 mA nominal current consumption



AA22 Series PA Driver/Siren Control SM33-2 Installation and Operation Manual

	+28 Vdc switched power output Use with PA110 and PA220 series amplifiers Can be selected as a radio with keyline serving as siren key
AA22-163*	Same as AA22-160, with locking PA/RADIO select switch
AA22-165*	Same as AA22-160, with 28 Vdc NVG-suitable lighting
AA22-167*	Same as AA22-160, with 5 Vdc NVG-suitable lighting
AA22-170*	Same as AA22-163, with 28 Vdc NVG-suitable lighting
AA22-492	Wail/Yelp swept siren, adjustable rate/tone Mode select switch, PA/Radio monitor 500 mVrms nominal audio output into 600 Ohms 450 mVrms nominal siren output into 600 Ohms Siren override at all times 70 mA nominal current consumption Used with PA250 and PA700 series amplifiers Can be selected as a radio with keyline serving as siren key
AA22-493	Wail/Yelp swept siren, adjustable rate/tone Mode select switch 100 mVrms nominal audio output into 600 Ohms 90 mVrms nominal siren output into 600 Ohms Siren override at all times 80 mA nominal current consumption Used with PA250 and PA700 series amplifiers Can be selected as a radio with keyline serving as siren key
AA22-495*	Same as AA22-492, with 28 Vdc NVG-suitable lighting
AA22-592*	Same as AA22-492, with 5 Vdc lighting
AA22-594*	Same as AA22-492, with 5 Vdc NVG-suitable lighting

* These products are included in this section for reference only. For more detailed information on these and other AA22 products, contact the Product Support Department at NAT Ltd.

Section 1 ends



AA22 Series PA Driver/Siren Control SM33-2 Installation and Operation Manual

Section 2 Installation

2.1 Introduction

Information in this section consists of unpacking and inspection procedures, installation procedures, post-installation checks and installation drawings for the AA22 Series PA Driver/Siren Control.

Review all notes, warnings and cautions.

2.2 Unpacking and Inspection

Unpack the equipment carefully and locate the warranty card. Inspect the unit visually for damage due to shipping and report all such claims immediately to the carrier involved. Check that all items listed below are present before proceeding and report any shortage immediately to your supplier:

- Warranty Card
- Operators Manual
- Certificate of Conformity or Release Certification

2.2.1 Warranty

All Northern Airborne Technology Ltd. products are warranted for 2 years from date of installation by an authorized NAT dealer, to be free of defects in workmanship or performance. This warranty covers all materials and labour, but is exclusive of any transport to deliver the defective unit to and from NAT or its designated warranty repair center, or any labour to remove or re-install the defective unit in the aircraft. Contact NAT for any questions regarding this warranty, its applicability to your units and/or for return authorization. NAT is the final arbitrator concerning warranty administration. Units which have been physically damaged, burned, immersed in water or otherwise abused beyond the scope of normal use will not be considered for warranty. **WARRANTY IS VOID UNLESS THE PRODUCT IS INSTALLED BY AN AUTHORIZED NAT DEALER.** Product for which a warranty card is not returned shall be warranted from date of manufacture.

2.3 Continued Airworthiness

Maintenance of the AA22 Series PA Driver/Siren Control is 'on condition' only. Periodic maintenance of this product is not required.



AA22 Series PA Driver/Siren Control SM33-2 Installation and Operation Manual

2.4 Installation Procedures

2.4.1 Warnings

WARNING:
High volume settings can cause hearing damage.
Set the headset volume control to the minimum volume setting prior to conducting tests, and slowly increase the headset volume to a comfortable listening level.

2.4.2 Cautions

CAUTION:
Never ground any output line from the AA22 or permanent damage may result. Use of a fully floating audio wattmeter or transformer-coupled meter is recommended. Always check ADF and compass calibration after installing external speakers or "PA" amplifiers. Significant single cycle errors may be caused by the concentration of steel and magnetic material.

2.4.3 Cabling and Wiring

All wire shall be selected in accordance with the original aircraft manufacturer's Maintenance Instructions or AC43.13-1B Change 1, Paragraphs 11-76 through 11-78. Unshielded wire types shall qualify to MIL-W-22759 as specified in AC43.13-1B Change 1, Paragraphs 11-85, 11-86, and listed in Table 11-11. For shielded wire applications, use Tefzel MIL-C-27500 shielded wire with solder sleeves (for shield terminations) to make the most compact and easily terminated interconnect. Follow the connector map in Section 2.7 as required.

Allow 3" from the end of the shielded wiring to the shield termination to allow the connector hood to be easily installed. Reference the interconnect drawing in Section 2.7 for shield termination details. Note that the hood is a "clamshell" hood, and is installed after the wiring is complete. Aircraft harnessing shall permit the unit to be lowered from the panel for easy access to all side adjustments. Do NOT mount the unit until all adjustments have been performed.

Maintain wire segregation and route wiring in accordance with the original aircraft manufacturers Maintenance Instructions.

Unless otherwise noted, all wiring shall be a minimum of 22 AWG, except power and ground lines, which shall be a minimum of 20 AWG. Reference the Interconnect drawing for additional specifications. Check that the ground connection is clean and well secured, and that it shares no path with any electrically noisy aircraft accessories such as blowers, turn and bank instruments or similar loads. Power to this unit must be supplied from a separate circuit breaker or fuse (fast blow), and not attached to any other circuit breaker without additional protection. Verify that the selected circuit breaker size and wire gauge are adequate for the installation using the techniques specified in AC43.13-1B Change 1, Paragraphs 11-47 through 11-51 and 11-66 through 11-69.



AA22 Series PA Driver/Siren Control SM33-2 Installation and Operation Manual

2.4.4 Post Installation Checks

2.4.4.1 Voltage/Resistance Checks

Do not attach the AA22 until the following conditions are met.

Check the following:

- a) Check P101, pin 1 and 2 for +28 Vdc relative to ground.
- b) Check P101, pin 14, 15 and 16 for continuity to ground (less than 0.5Ω).
- c) Check P101, pin 3 for the presence of the lamp dimmer voltage.

Check the following for AA20-030 and AA20-430

- d) Check P101, pin 10 for continuity to ground (less than 0.5Ω). This ground is installation specific and may be a 'hard' ground or supplied by a momentary switch (siren trigger).

2.4.4.2 Operational Checks

The PA system is not intended to be operated in a linear volume manner (i.e., it is not like a stereo system). The PA is designed to provide high levels of audio power under difficult conditions and does so by sacrificing some of the high fidelity for a higher average power output. The volume control on the AA22 is not intended to provide linear operations from the PA system and will result in broken and sporadic output from the PA when insufficient levels are delivered to the AA22 and/or to the power amplifier unit from the AA22.

For most RADIO and PA (voice) operations, it is suggested that the AA22 volume control be set to maximum (fully cw). If the system is overdriving, reduce the AA22 volume setting.

To check the system, the aircraft must be moved outside and away from as many reflective surfaces as possible. It is not recommended to operate the PA microphone on the ground, as a high risk exists for audio coupling and feedback. However, if the test is to be conducted on the ground, the aircraft should be positioned on a grassy surface to help reduce the distortion produced by sound reflected from concrete or asphalt. It is also beneficial to stuff the speaker projectors with soft rubberized foam to reduce the risk of feedback and distortion.

Advise all nearby personnel that PA system tests are to be done.

Start by checking the Siren Circuit for proper operation and tone/rate adjustment. The Siren always operates at 100% output from the AA22 and should drive the PA's to full output on audio peaks. The Level trimpot of the AA22 will be set at the factory to provide rated output at full front panel volume control adjustment.

Once the siren operation is satisfactory, you may try RADIO operations through the AA22. To achieve full output capability from the AA22, a signal of 2.5 Vrms must be delivered to the AA22 Radio audio input and the AA22 volume must be set to maximum. Lower levels of input signal or volume settings will result in poor output audio (very broken).

For PA (voice) tests, it is best that the aircraft is flown in an approximately 200 foot hover and commands are given to a human ground target for visual response to the commands. Remember, the human target should be positioned in the area that the speaker system is designed to project the audio to. This will depend on speaker orientation and the height of the aircraft. Remove all



AA22 Series PA Driver/Siren Control SM33-2 Installation and Operation Manual

sound absorbing material from the speakers before flying the aircraft. To achieve the best operation, all voice commands must be spoken slowly and clearly, with extra emphasis on each word.

To determine the operational capability of the system, put the aircraft in a hover and with the target properly positioned, provide PA instruction to the target to accomplish a certain task that will give visual cue to the flight crew that the target has understood the instructions (i.e., "touch your head", "sit down", "turn around", etc.)

2.4.4.3 Power On Checks

Power up the aircraft's systems and confirm normal operation of all functions of the AA22. Refer to Section 3 (Operation) for specific operational details.

- a) Turn on all of the radios and other accessories required for this system. Check that the power ON LED on the AA22 illuminates when the power switch is up.
- b) Key the siren using the front panel button or remote siren key. The siren should sound and the level should be at maximum volume (the front panel level control does not affect the siren). If the siren (rate or tone) needs adjustment there are two trimpots on the left side of the AA22.
- c) Select the rest of the audio system as required to allow connection of the pilot's mic to the 'PA' and key the cyclic switch for transmit. The mic audio should be heard on the 'PA' speakers. Adjust the front panel level control for the desired volume.
- d) Check preset adjustments are completed before aircraft departure.

- Notes:**
1. Note that PA audio has priority in the AA22 system and it will be heard even if the panel switch is selected to 'RADIO'. Check for correct radio operation and note what volume settings will produce a suitable external paging level..
 2. A faint audio signal may be heard at the speaker (even when the system is not paging) due to the very high gain of this system and stray coupling in the wiring. It should not be audible in flight.

Upon satisfactory completion of all performance checks, make all required log book entries, electrical load, weight and balance amendments and other documentation as required by your local regulatory agency before releasing the aircraft for service.

2.5 Adjustments and Connections

If any preset requires adjustment, be sure this is carried out before the aircraft leaves and that the unit and its mating connector are secured before departure.

If the siren does not suit the specific requirements of a given installation, the following adjustments are available:

1. Base tone setting - potentiometer marked TONE.
2. Sweep rate setting - potentiometer marked RATE.

These controls are accessible through holes on the left side of the unit as shown in Figure 1.



AA22 Series PA Driver/Siren Control SM33-2 Installation and Operation Manual

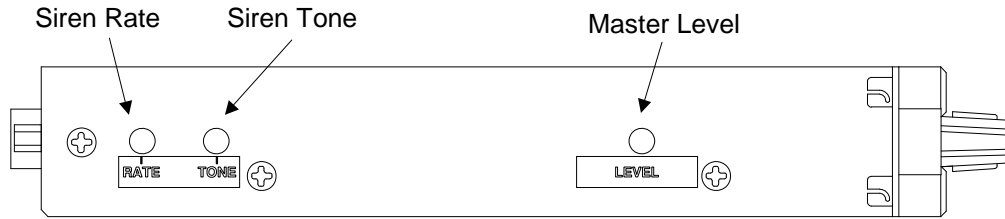

Figure 1: Tone and Rate Controls

2.6 Accessories Required But Not Supplied

Installation kit p/n AA20-IKC (crimp) is required to complete the installation.

AA20-IKC 25-pin D-min Female Crimp Kit (NAT Part No. D25SL-IKC) consists of

Quantity	Description	NAT Part No.
1	D-min 25 Socket Housing	20-21-025
25	MS Crimp Socket	20-26-901
1*	Jack Screw Set	20-27-002
1*	Lock Clip Set	20-27-004
1	50 Pin Connector Hood	20-29-026

* Use as required.

2.7 Installation Drawings

Use of the "#" symbol in the REV. column indicates that the document is listed elsewhere in the manual. Refer to the applicable NAT Part No. to locate the referenced document.

DOCUMENT	REV.	DESCRIPTION	TYPE	SERIAL NO.
AA22-110				
AA22\110\403-0	1.02	PA Driver/Siren System	Interconnect	Up to 4019
AA22\110\403-0	1.10	PA Driver/Siren System	Interconnect	4020 and up
AA22\110\405-0	1.02	PA Driver/Siren System	Connector Map	All
AA22\110\905-0	1.02	PA Driver/Siren System	Faceplate	Up to 4126
AA22\110\905-0	1.10	PA Driver/Siren System	Faceplate	4127 and up
AA22\160\922-0	1.00	PA Driver/Siren System	Mechanical Installation	All
AA22-160				
AA22\160\403-0	1.01	PA Driver/Siren System	Interconnect	Up to 2900
AA22\160\403-0	1.10	PA Driver/Siren System	Interconnect	2901 and up
AA22\160\405-0	1.02	PA Driver/Siren System	Connector Map	All
AA22\160\905-0	1.02	PA Driver/Siren System	Faceplate	Up to 4126
AA22\160\905-0	1.10	PA Driver/Siren System	Faceplate	4127 and up
AA22\160\922-0	#	PA Driver/Siren System	Mechanical Installation	



AA22 Series PA Driver/Siren Control SM33-2 Installation and Operation Manual

AA22-492

AA22\492\403-0	1.10	PA Driver/Siren System	Interconnect	All
AA22\492\403-1	1.10	PA Driver/Siren System	Interconnect	All
AA22\492\403-2	1.10	PA Driver/Siren System	Interconnect	All
AA22\492\405-0	1.11	PA Driver/Siren System	Connector Map	All
AA22\492\905-0	1.02	PA Driver/Siren System	Faceplate	Up to 4126
AA22\492\905-0	1.10	PA Driver/Siren System	Faceplate	4127 and up
AA22\492\922-0	1.00	PA Driver/Siren System	Mechanical Installation	All

AA22-493

AA22\493\403-1	1.00	PA Driver/Siren System	Interconnect	All
AA22\493\403-2	1.00	PA Driver/Siren System	Interconnect	All
AA22\493\405-0	1.01	PA Driver/Siren System	Connector Map	All
AA22\493\905-0	1.00	PA Driver/Siren System	Faceplate	Up to 4126
AA22\493\905-0	1.10	PA Driver/Siren System	Faceplate	4127 and up
AA22\492\922-0	#	PA Driver/Siren System	Mechanical Installation	

Section 2 ends following the above documents

REVOLUTIONS

REV	DESCRIPTION	DATE	BY
1.01	FORMAT CHANGES	APR 4/95	LH
1.02	NOTES 2 - 5 ADDED, FORMAT CHANGES, DRAWING CORRECTIONS	AUG 14/98	MWS

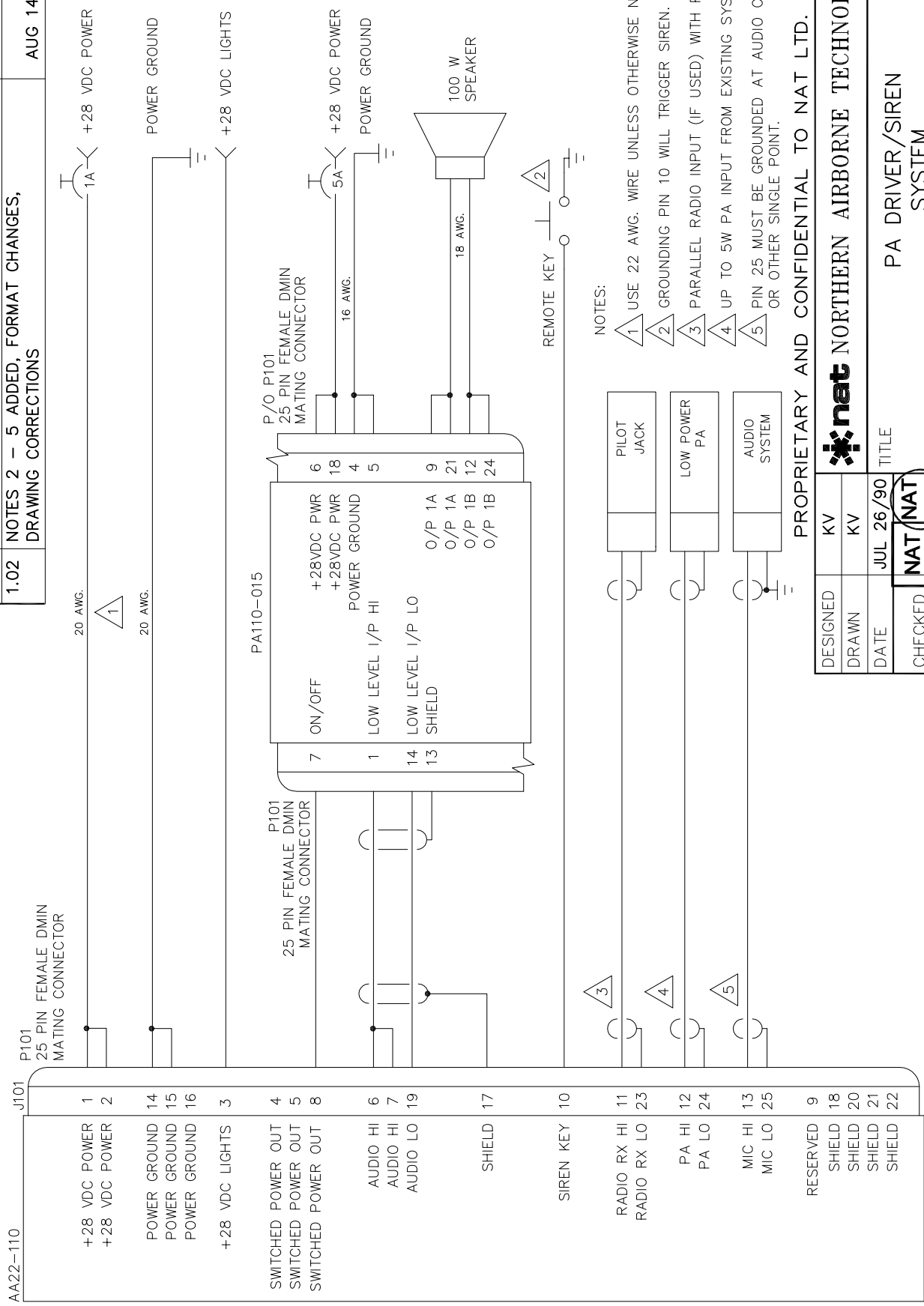

NOTES:

- 1 USE 22 AWG. WIRE UNLESS OTHERWISE NOTED.
- 2 GROUNDING PIN 10 WILL TRIGGER SIREN.
- 3 PARALLEL RADIO INPUT (IF USED) WITH PILOT H/S.
- 4 UP TO 5W PA INPUT FROM EXISTING SYSTEM.
- 5 PIN 25 MUST BE GROUNDED AT AUDIO CONTROLLER OR OTHER SINGLE POINT.

PROPRIETARY AND CONFIDENTIAL TO NAT LTD.

DESIGNED	KV	TITLE	
DRAWN	KV	PA DRIVER/SIREN SYSTEM	
DATE	JUL 26/90	CAGE CODE	PART NO.
CHECKED	NAT 214 106	3AB01	AA22-110
APPROVED	NAT 107	DWG. TYPE	INTERCONNECT
FILE	403-0102.DWG	DWG. NO.	AA22\110\403-0



nat NORTHERN AIRBORNE TECHNOLOGY LTD.

REVISIONS			
REV	DESCRIPTION	DATE	BY
1.01	FORMAT CHANGES	APR 4/95	LH
1.02	NOTES 2 - 5 ADDED, FORMAT CHANGES, DRAWING CORRECTIONS	AUG 14/98	MWS
1.10	REFER TO DOCCR02098 FOR DETAILS.	FEB 25/08	MWS

NOTES:

1. ALL WIRES SHOULD BE 22 AWG UNLESS OTHERWISE SPECIFIED. ALL UNSHIELDED WIRE SHALL BE SELECTED IN ACCORDANCE WITH AC43.13-1B CHANGE 1, PARAGRAPHS 11-76 THROUGH 11-78. WIRE TYPES SHOULD BE TO MIL-W-22759 AS SPECIFIED IN AC43.13-1B CHANGE 1, PARAGRAPHS 11-85, 11-86 AND LISTED IN TABLE 11-11. ALL SHIELDED WIRE/CABLE SHOULD BE IN ACCORDANCE WITH MIL-C-27500.
2. GROUNDING PIN 10 WILL TRIGGER SIREN.
3. PARALLEL RADIO INPUT (IF USED) WITH PILOT H/S.
4. UP TO 5W PA INPUT FROM EXISTING SYSTEM.
5. PIN 25 MUST BE GROUNDED AT AUDIO CONTROLLER OR OTHER SINGLE POINT.

DEFINITIONS:

RESERVED: MAY BE CONNECTED AND USED IN THE FUTURE. THE CIRCUITRY MAY BE PRESENT OR ADDED TO ACTIVATE THE FUNCTION. THE PIN MAY BE USED FOR TEST PURPOSES. THERE IS NO EXTERNAL CONNECTION.

CONFIDENTIAL AND PROPRIETARY TO NAT LTD.

DESIGNED	KV	 NAT NORTHERN AIRBORNE TECHNOLOGY LTD.				
DRAWN	KV					
DATE	JUL 26/90	TITLE PA DRIVER/SIREN SYSTEM				
CHECKED	NAT 255					
APPROVED	NAT 114	SIZE A	CAGE CODE 3AB01	PART NO. AA22-110	REV. 1.10	SHEET 1/2
FILE	403-0.DWG	DWG. TYPE	INTERCONNECT	DWG. NO.	AA22\110\403-0	



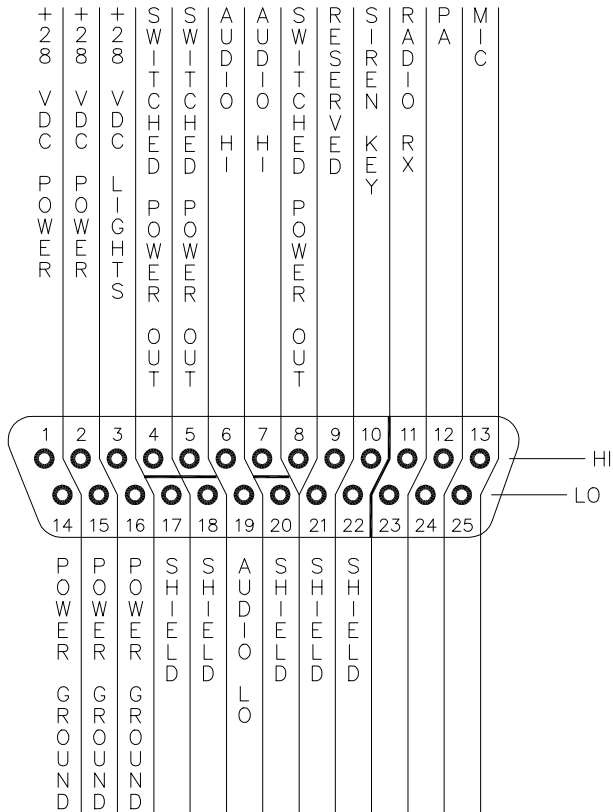

REVISIONS			
REV	DESCRIPTION	DATE	BY
1.01	FORMAT CHANGES	FEB 14/96	MWS
1.02	NOTES REMOVED, FORMAT CHANGES, DRAWING CORRECTIONS.	AUG 14/98	MWS

P101
25 PIN FEMALE D-MIN
MATING CONNECTOR



VIEW IS FROM REAR OF AIRFRAME CONNECTOR



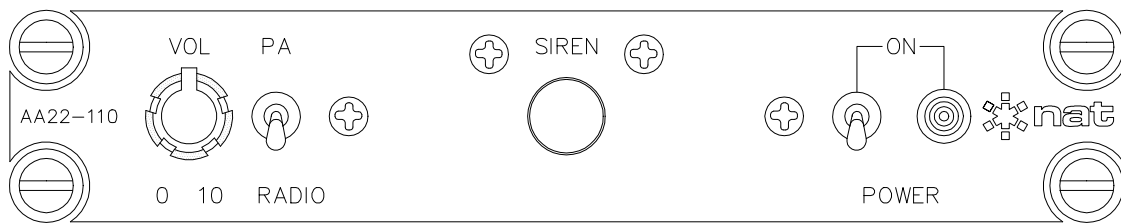

PROPRIETARY AND CONFIDENTIAL TO NAT LTD.

DESIGNED	KV	 NAT NORTHERN AIRBORNE TECHNOLOGY LTD.			
DRAWN	MWS				
DATE	NOV 29/90	TITLE PA DRIVER/SIREN SYSTEM			
CHECKED	 				
APPROVED		SIZE A	CAGE CODE 3AB01	PART NO. AA22-110	REV. 1.02 SHEET 1/1
FILE	405-0102.DWG	DWG. TYPE	CONNECTOR MAP	DWG. NO.	AA22\110\405-0

REVISIONS			
REV	DESCRIPTION	DATE	BY
1.01	FORMAT CHANGES	FEB 26/96	TGM
1.02	ADDED SHEET 2, FORMAT CHANGES	AUG 5/98	MWS





PROPRIETARY AND CONFIDENTIAL TO NAT LTD.

DESIGNED	KV	 NORTHERN AIRBORNE TECHNOLOGY LTD.				
DRAWN	KV					
DATE	JAN 25/90	TITLE				PA DRIVER/SIREN SYSTEM
CHECKED	 					
APPROVED		SIZE	CAGE CODE	PART NO.	REV.	SHEET
		A	3AB01	AA22-110	1.02	1/2
FILE	905-0102.DWG	DWG. TYPE	FACEPLATE	DWG. NO.	AA22\110\905-0	

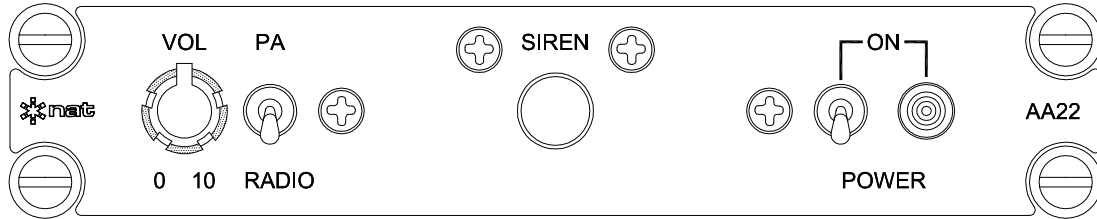
REVISIONS			
REV	DESCRIPTION	DATE	BY
1.01	FORMAT CHANGES.	FEB 26/06	TGM
1.02	ADDED SHEET 2, FORMAT CHANGES.	AUG 5/98	MWS
1.10	ECR #1079 - REMOVED "-110". DOCCR01656 - FORMAT CHANGES.	APR 15/08	MWS



CONFIDENTIAL AND PROPRIETARY TO NAT LTD.

DESIGNED	KV	 nat NORTHERN AIRBORNE TECHNOLOGY LTD.				
DRAWN	KV					
DATE	JAN 25/90	TITLE	PA DRIVER/SIREN SYSTEM FRONT VIEW			
CHECKED						
APPROVED		SIZE	CAGE CODE	PART NO.	REV.	SHEET
FILE	905-0.DWG	A	3AB01	AA22-110	1.10	1/3
DWG. TYPE		FACEPLATE		DWG. NO. AA22\110\905-0		

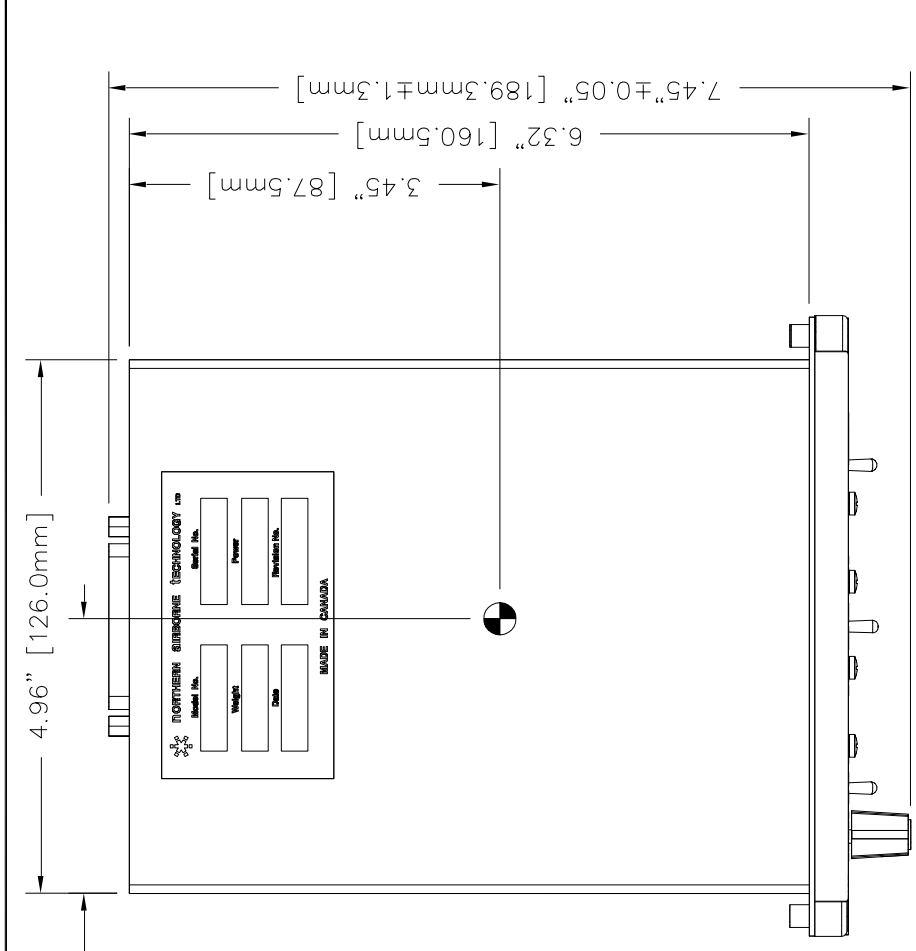

WEIGHT: 1.00 lbs. (0.45 kg.)
 CENTER OF GRAVITY ±0.05

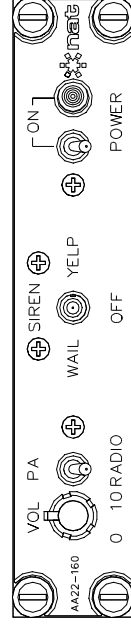
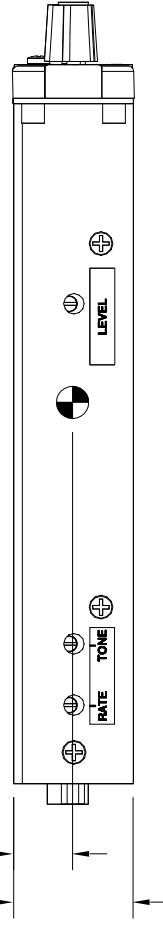

5.75" [146.1mm]

PROPRIETARY AND CONFIDENTIAL TO NAT LTD.

NAT NORTHERN AIRBORNE TECHNOLOGY LTD.	
DESIGNED DRAWN	KV JJJ/TAT
DATE	APR 26/00
CHECKED	NAT NAT 2001 214
APPROVED	NAT 107
TOLERANCES UNLESS STATED OTHERWISE 0.X=+/-0.030 0.XX=+/-0.010 0.XXX=+/-0.005 0.XXXX=+/-0.002 ANGLE=+/- 0.5 DEG.	DIMENSIONS IN INCHES THIRD ANGLE PROJECTION
MATERIAL	SIZE A
FINISH	CAGE CODE 3AB01
	PART NO. AA22-160
	REV. 1.00
	SHEET 1/1
FILE 922-0100.DWG	DWG. TYPE MECH. INSTALLATION
	DWG. NO. AA22\160\922-0

TITLE
PA / SIREN SYSTEM

AA22-160 EXTERNAL CONNECTIONS

AIRFRAME CONNECTIONS

AA22-160
P101 - DB25S

+28VDC POWER	1
+28VDC POWER	2
POWER GROUND	14
POWER GROUND	15
POWER GROUND	16
+28V LIGHT DIM	3
SW. POWER OUT (FOR OLDER UNITS USE PINS 4 AND 5)	8
AUDIO OUT HI	6
AUDIO OUT LO	19
SIREN KEYLINE	10
RADIO INPUT HI	11
RADIO INPUT LO	23
HI LEVEL MIC IN RETURN	12 24
LO LEVEL MIC IN RETURN	13 25

Confidential and Proprietary to NAT

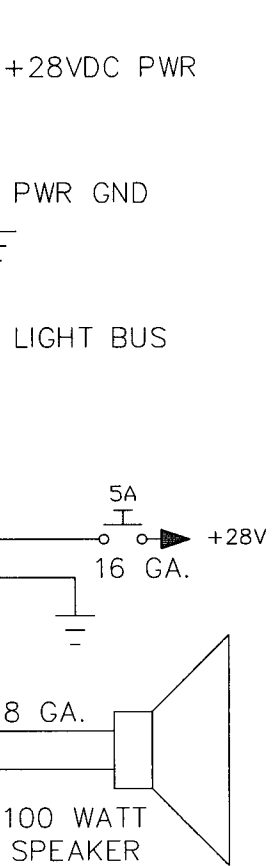
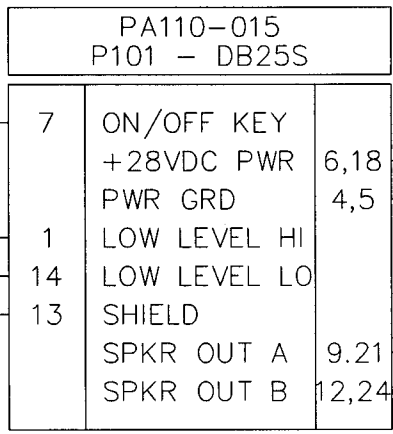

SUITABLE SPEAKER IS FEDERAL SIGNAL TS-100 (11 OHMS, 100 WATTS)

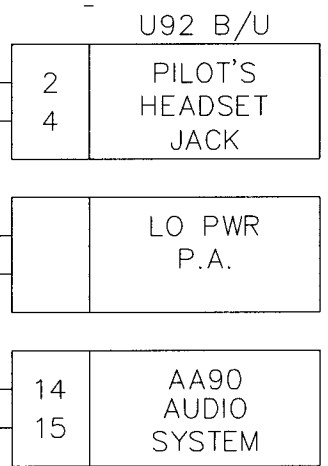

* ALL WIRE 22 GA. EXCEPT AS NOTED

REVISION		DATE	*nat NORTHERN AIRBORNE TECHNOLOGY LTD.			
1.00		JULY 23/90	DESIGNED BY	DESCRIPTION		
1.01		APR 4/95	K. VEITCH	PA/SIREN SYSTEM		
			DRAWN BY	PART NUMBER	DRAWING TYPE	SHEET
			KV/LH	AA22-160	INTERCONNECT	1/1
			APPROVED BY	DRAWING NUMBER	FILE NUMBER	
				AA22\160\403-0	AA22\160\403-0101	

REVISIONS			
REV	DESCRIPTION	DATE	BY
1.01	FORMAT CHANGES.	APR 4/95	LH
1.10	ECR #1475 - REFER TO ECR.	APR 25/00	TAT

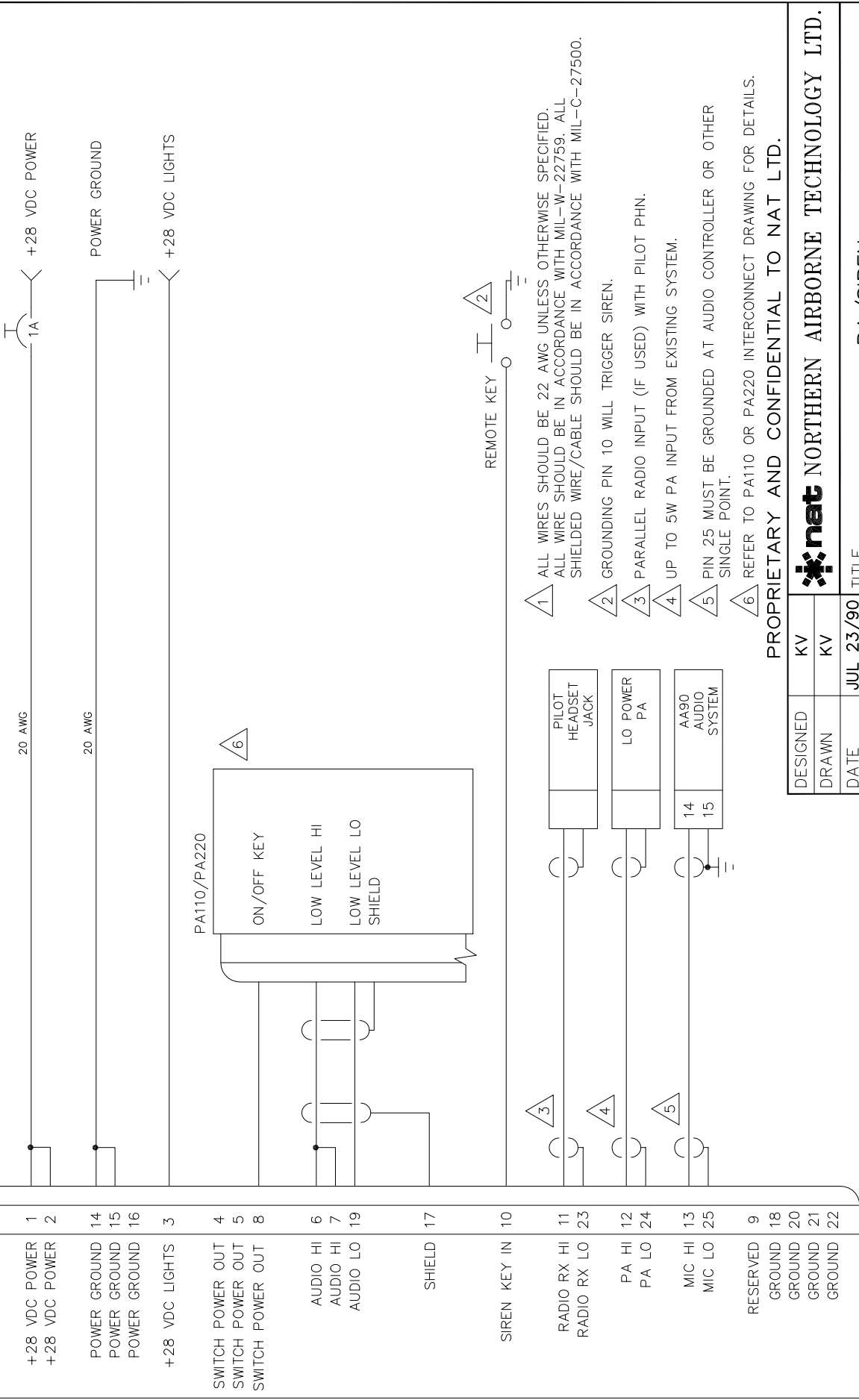

PROPRIETARY AND CONFIDENTIAL TO NAT LTD.

nat NORTHERN AIRBORNE TECHNOLOGY LTD.

DESIGNED	KV	TITLE	
DRAWN	KV	PA/SIREN SYSTEM	
DATE	JUL 23/90	SIZE	A
CHECKED	NAT 214 104	CAGE CODE	3AB01
APPROVED	NAT 107	PART NO.	AA22-160
FILE	403-0110.DWG	DWG. TYPE	INTERCONNECT
		DWG. NO.	AA22\160\403-0
		REV.	1.10
		SHEET	1/1

DEFINITION:

RESERVED: MAY BE CONNECTED AND USED IN THE FUTURE. THE CIRCUITRY MAY BE PRESENT OR ADDED TO ACTIVATE THE FUNCTION. THE PIN MAY BE USED FOR TEST PURPOSES. THERE IS NO EXTERNAL CONNECTION.

REVISIONS			
REV	DESCRIPTION	DATE	BY
1.01	FORMAT CHANGES.	FEB 14/96	MWS
1.02	ECR #1475 - NOTES MOVED TO INTERCONNECT DWG, FORMAT CHANGES.	MAY 9/00	TAT

P101
 25 PIN FEMALE D-MIN
 MATING CONNECTOR

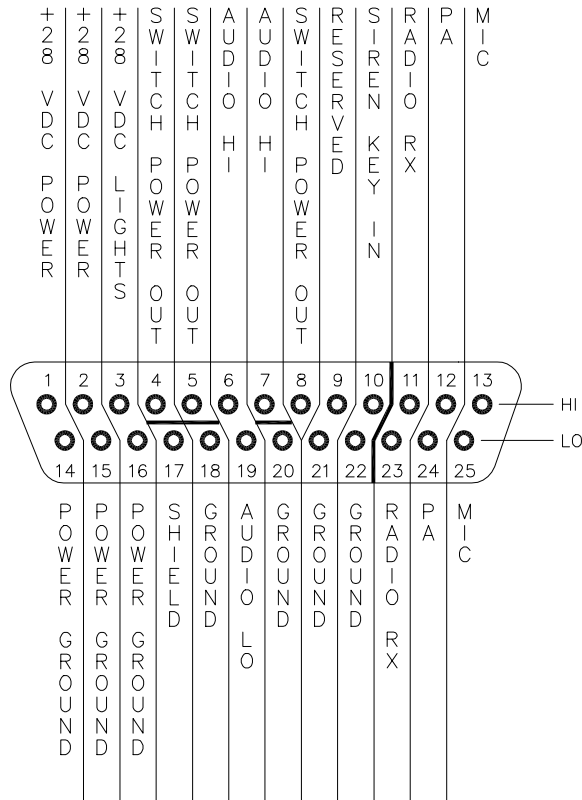

VIEW IS FROM REAR OF AIRFRAME CONNECTOR



PROPRIETARY AND CONFIDENTIAL TO NAT LTD.

DESIGNED	KV	nat NORTHERN AIRBORNE TECHNOLOGY LTD.				
DRAWN	MWS					
DATE	NOV 29/90	TITLE PA/SIREN SYSTEM				
CHECKED	<div style="border: 1px solid black; padding: 2px; width: 40px; margin: 0 auto;"> NAT 223 </div>					
APPROVED	<div style="border: 1px solid black; border-radius: 50%; padding: 5px; width: 40px; margin: 0 auto;"> NAT 107 </div>	SIZE A	CAGE CODE 3AB01	PART NO. AA22-160	REV. 1.02	SHEET 1/1
FILE	405-0102.DWG	DWG. TYPE	CONNECTOR MAP	DWG. NO.	AA22\160\405-0	

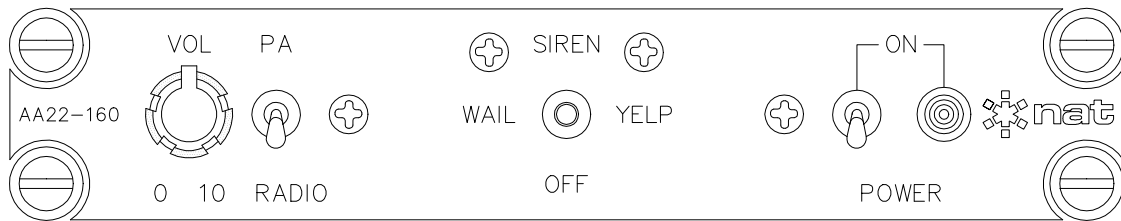
REVISIONS			
REV	DESCRIPTION	DATE	BY
1.01	FORMAT CHANGES	APR 4/95	LH
1.02	ECR #873, KNOB TYPE, ENGRAVED TEXT CHANGED	JUL 4/97	MWS



Confidential and Proprietary to NAT

DESIGNED	KV	 NORTHERN AIRBORNE TECHNOLOGY LTD.				
DRAWN	KV					
DATE	JUL 25/90	TITLE	PA DRIVER/SIREN SYSTEM			
CHECKED	NAT PROD. 133					
APPROVED		SIZE	CAGE CODE	PART NO.	REV.	SHEET
		A	3AB01	AA22-160	1.02	1/2
FILE	905-0102.DWG	DWG. TYPE	FACEPLATE	DWG. NO.	AA22\160\905-0	

REVISIONS			
REV	DESCRIPTION	DATE	BY
1.01	FORMAT CHANGES.	APR 4/95	LH
1.02	ECR #873, KNOB TYPE, ENGRAVED TEXT CHANGED.	JUL 4/97	MWS
1.10	ECR #1079 - REMOVED "-160". DOCCR01656 - FORMAT CHANGES.	APR 15/08	MWS

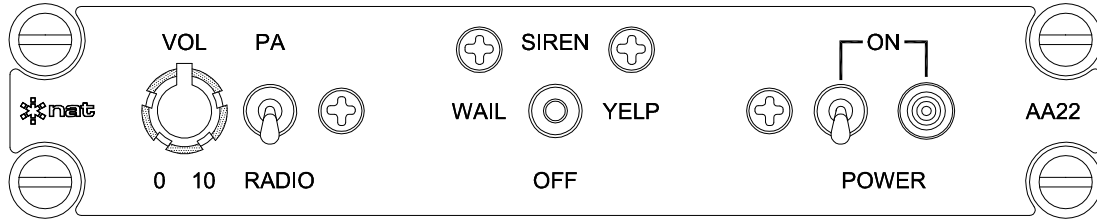

CONFIDENTIAL AND PROPRIETARY TO NAT LTD.

DESIGNED	KV	 NORTHERN AIRBORNE TECHNOLOGY LTD.				
DRAWN	KV					
DATE	JUL 25/90		TITLE			
CHECKED	NAT 255	PA DRIVER/SIREN SYSTEM FRONT VIEW				
APPROVED	NAT 131	SIZE A	CAGE CODE 3AB01	PART NO. AA22-160	REV. 1.10	SHEET 1/3
FILE	905-0.DWG	DWG. TYPE		FACEPLATE	DWG. NO. AA22\160\905-0	

REVISIONS			
REV	DESCRIPTION	DATE	BY
1.01	ECR #1481 – CHANGED NOTES 1, 3 & 7; ADDED NOTES 8 & 9; FORMAT CHANGES.	SEP 26/00	TAT
1.10	DOCCR01476 – CHANGED TO SHOW OPTIONAL LO POWER PA CONNECTIONS. UPDATED TEMPLATE.	JUN 5/06	TAT

AA22-492 INSTALLATION NOTES

NOTES:

1. ALL WIRES SHOULD BE 22 AWG UNLESS OTHERWISE SPECIFIED. ALL UNSHIELDED WIRE SHALL BE SELECTED IN ACCORDANCE WITH AC43.13-1B CHANGE 1, PARAGRAPHS 11-76 THROUGH 11-78. WIRE TYPES SHOULD BE TO MIL-W-22759 AS SPECIFIED IN AC43.13-1B CHANGE 1, PARAGRAPHS 11-85, 11-86 AND LISTED IN TABLE 11-11. ALL SHIELDED WIRE/CABLE SHOULD BE IN ACCORDANCE WITH MIL-C-27500.
2. OPTIONAL. PARALLEL TO HEADPHONE (1 ONLY) CONNECTION FOR MONITORING RADIOS VIA EXTERNAL P.A. SPEAKER.
3. OR CARBON-EQUIVALENT/AMPLIFIED DYNAMIC MICROPHONE.
4. MIC INPUT LO (PIN 25) MUST GO TO EXTERNAL GROUND TO EXCITE MICROPHONE, IF NOT PROVIDED BY AUDIO SYSTEM.
5. FOR CYCLIC-SWITCH KEYING, WIRE AS SHOWN. FOR FRONT-PANEL AUTO-KEYING, GROUND PIN 10.
6. SHIELD TO REDUCE INTERFERENCE WITH OTHER SYSTEMS.
7. ISOLATED TRANSFORMER OUTPUT. 'AUDIO OUT LO' MUST BE TERMINATED AT P1 'C'.
8. SWITCH POWER OUT (PIN 8) RATED 400mA @ 28VDC.
9. K1 RELAY NAT P/N 65-80-200 OR EQUIVALENT. FLT1 RF FILTER NAT P/N 22-00-003A OR EQUIVALENT.
10. UP TO 5W PA INPUT FROM EXISTING SYSTEM.

DEFINITIONS:

- N/C: NO CONNECTION. THE PIN IS NOT CONNECTED TO ANYTHING INTERNALLY, AND THEREFORE SHALL HAVE NO CONNECTION EXTERNALLY.
- N/C SPARE: NO CONNECTION INTERNALLY, BUT A SPARE WIRE SHALL BE INSTALLED IN THE WIRE HARNESS.
- RESERVED: MAY BE CONNECTED AND USED IN THE FUTURE. THE CIRCUITRY MAY BE PRESENT OR ADDED TO ACTIVATE THE FUNCTION. THE PIN MAY BE USED FOR TEST PURPOSES. THERE IS NO EXTERNAL CONNECTION.
- RESERVED SPARE: RESERVED, BUT INSTRUCTIONS SHALL BE FOLLOWED TO ACTIVATE THE CIRCUITRY. A SPARE WIRE SHALL BE INSTALLED IN THE WIRE HARNESS.

CONFIDENTIAL AND PROPRIETARY TO NAT LTD.

DESIGNED	RL	 NAT NORTHERN AIRBORNE TECHNOLOGY LTD.				
DRAWN	TAT					
DATE	MAY 26/06	TITLE				PA/SIREN SYSTEM
CHECKED	NAT 255					
APPROVED	NAT 131	SIZE	CAGE CODE	PART NO.	REV.	SHEET
		A	3AB01	AA22-492	1.10	1/3
FILE	403-0.DWG	DWG. TYPE	INTERCONNECT	DWG. NO.	AA22\492\403-0	

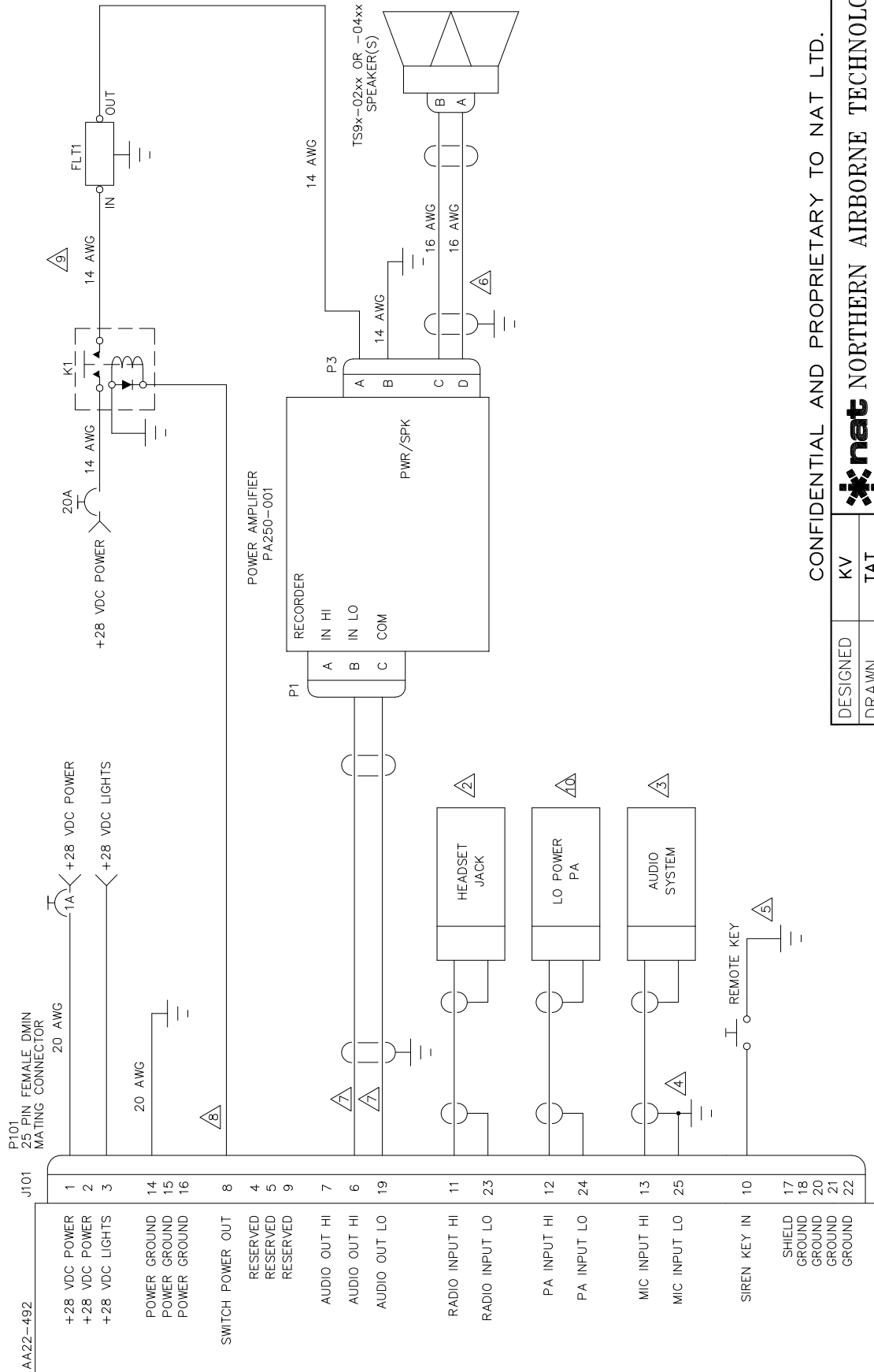

CONFIDENTIAL AND PROPRIETARY TO NAT LTD.

DESIGNED	KV	TITLE		
DRAWN	TAT	PA/SIREN SYSTEM 250 WATT		
DATE	SEP 19/02	SIZE	CAGE CODE	PART NO.
CHECKED	NAT 255	A	3AB01	AA22-492
APPROVED	NAT 131			
FILE	403-0.DWG	DWG. TYPE	INTERCONNECT	DWG. NO. AA22\492\403-1

nat NORTHERN AIRBORNE TECHNOLOGY LTD.

REV. SHEET
1.10 2/3

AA22-492

J101

P101
25 PIN FEMALE DMIN
MATING CONNECTOR

1	+28 VDC POWER
2	+28 VDC POWER
3	+28 VDC LIGHTS
14	POWER GROUND
15	POWER GROUND
16	POWER GROUND
8	SWITCH POWER OUT
4	RESERVED
5	RESERVED
9	RESERVED
7	AUDIO OUT HI
6	AUDIO OUT HI
19	AUDIO OUT LO
11	RADIO INPUT HI
23	RADIO INPUT LO
12	PA INPUT HI
24	PA INPUT LO
13	MIC INPUT HI
25	MIC INPUT LO
10	SIREN KEY
17	SHIELD
18	GROUND
20	GROUND
21	GROUND
22	GROUND

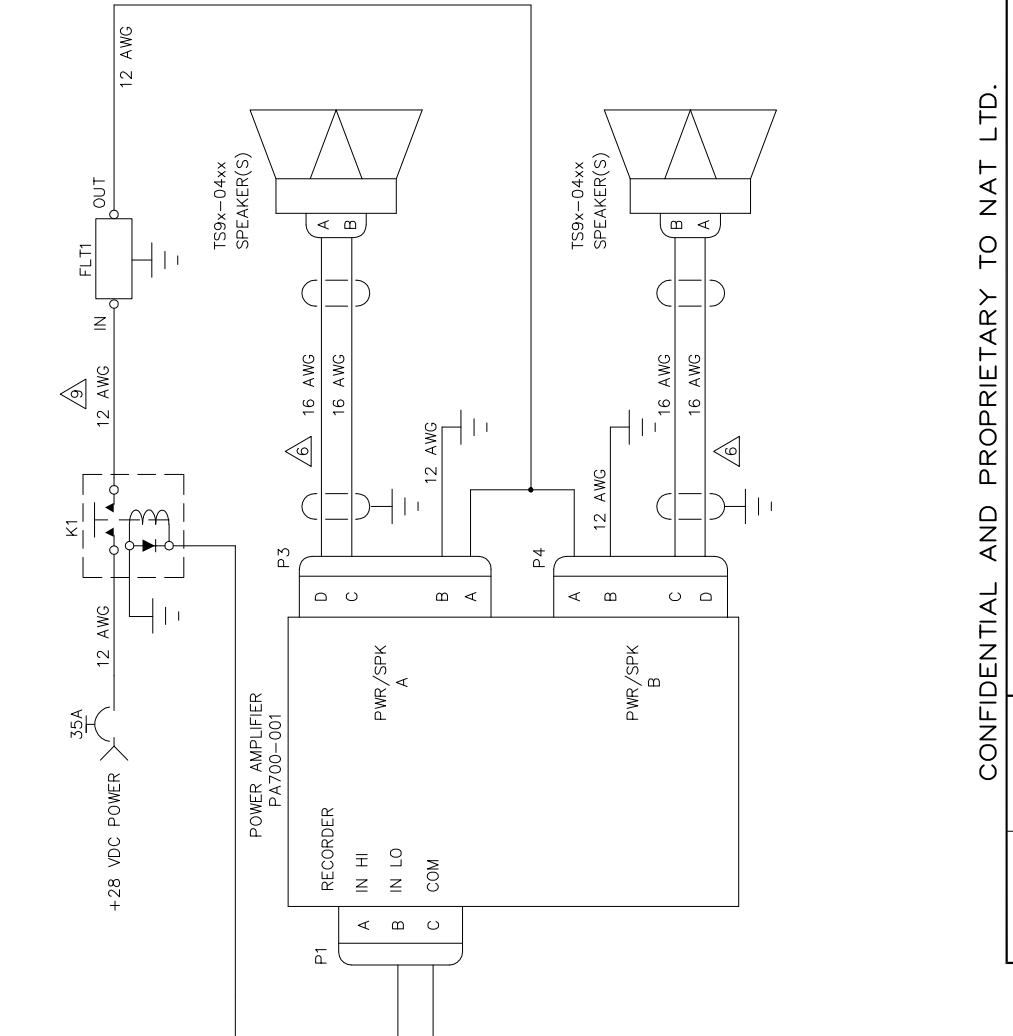
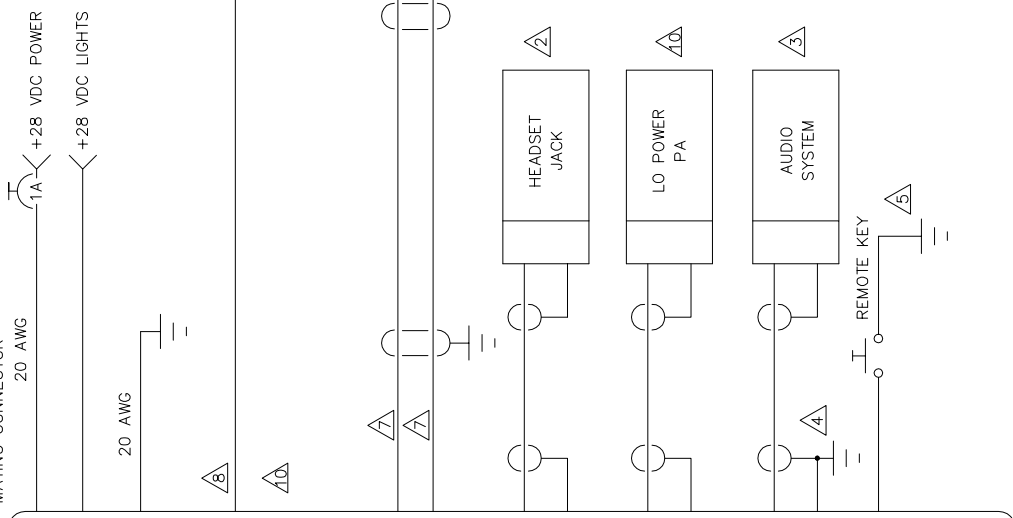

CONFIDENTIAL AND PROPRIETARY TO NAT LTD.

DESIGNED	KV			
DRAWN	TAT			
DATE	SEP 19/02	TITLE		
CHECKED	NAT 255	PA/SIREN SYSTEM 700 WATT		
APPROVED	NAT 131	SIZE	CAGE CODE	REV.
		A	3AB01	1.10
FILE	403-0.DWG	DWG. TYPE	INTERCONNECT	DWG. NO.
				AA22\492\403-2
			PART NO.	SHEET
			AA22-492	3/3

nat NORTHERN AIRBORNE TECHNOLOGY LTD.

REVISIONS			
REV	DESCRIPTION	DATE	BY
1.01		APR. 5/95	LH
1.11	PIN 19 ISOLATED	FEB 14/96	MWS

Confidential and Proprietary to NAT

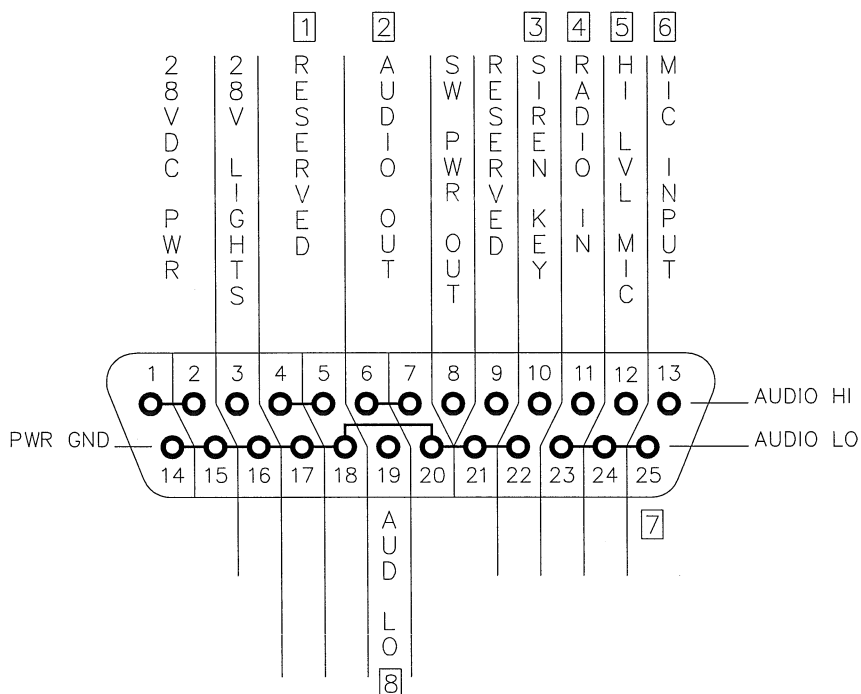

- 1 PINS 4 AND 5 HAVE NO CONNECTION.
- 2 FULL AUDIO OUTPUT TYP. 100mV INTO 100 OHMS.
- 3 GROUND AT PIN 10 WILL TRIGGER SIREN.
- 4 RADIO INPUT TYP. 2.5V FOR FULL OUTPUT.
- 5 UP TO 5W PAGE INPUT.
- 6 MIC INPUT TYP. 250mV FOR FULL OUTPUT. BIASED.
- 7 MUST GO TO EXTERNAL GROUND TO EXCITE MIC.
- 8 ISOLATED TRANSFORMER OUTPUT. MUST PROVIDE GROUND AT P.A. END.

DESIGNED	-	NAT NORTHERN AIRBORNE TECHNOLOGY LTD.				
DRAWN	KEH					
DATE	JAN 10/89	TITLE PA/SIREN SYSTEM				
CHECKED	NAT 201					
APPROVED	NAT 107	SIZE	CAGE CODE	PART NO.	REV.	SHEET
		A	3AB01	AA22-492	1.11	1/1
FILE	405-0111.DWG	DWG. TYPE	CONNECTOR MAP	DWG. NO.	AA22\492\405-0	

REVISIONS			
REV	DESCRIPTION	DATE	BY
1.01	FORMAT CHANGES.	APR 5/95	LH
1.02	UPDATED TO CURRENT NAT FORMAT.	NOV 16/98	TAT

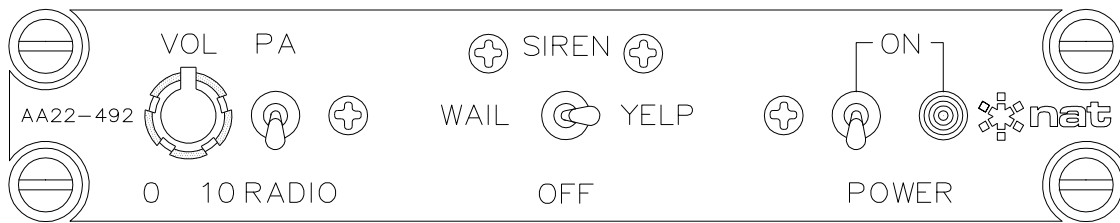

PROPRIETARY AND CONFIDENTIAL TO NAT LTD.

DESIGNED	-	NORTHERN AIRBORNE TECHNOLOGY LTD.				
DRAWN	-					
DATE	JAN 25/91	TITLE	PA/SIREN SYSTEM			
CHECKED	NAT 211	NAT 214	PROD. 105			
APPROVED	NAT 107	SIZE	CAGE CODE	PART NO.	REV.	SHEET
		A	3AB01	AA22-492	1.02	1/1
FILE	905-0102.DWG	DWG. TYPE	FACEPLATE	DWG. NO.	AA22\492\905-0	

REVISIONS			
REV	DESCRIPTION	DATE	BY
1.01	FORMAT CHANGES.	APR 5/95	LH
1.02	UPDATED TO CURRENT NAT FORMAT.	NOV 16/98	TAT
1.10	ECR #1079 - REMOVED "-492", DOCCR01656 - ADD'D SHEETS 2 & 3, FORMAT CHG'S. DOCCR02320 - ADDED ANNUNCIATOR HOLE.	APR 15/08	MWS

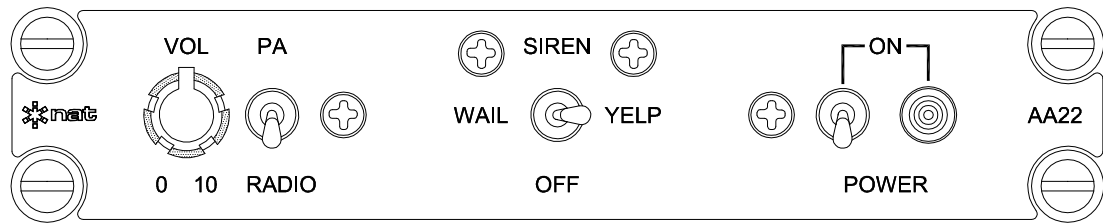

CONFIDENTIAL AND PROPRIETARY TO NAT LTD.

DESIGNED	-	NAT NORTHERN AIRBORNE TECHNOLOGY LTD.				
DRAWN	-					
DATE	JAN 25/91	TITLE				
		PA DRIVER/SIREN SYSTEM				
		FRONT VIEW				
CHECKED		SIZE	CAGE CODE	PART NO.	REV.	SHEET
APPROVED		A	3AB01	AA22-492	1.10	1/3
FILE	905-0.DWG	DWG. TYPE	FACEPLATE	DWG. NO.	AA22\492\905-0	

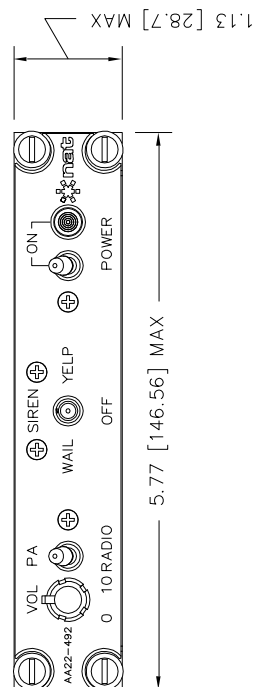
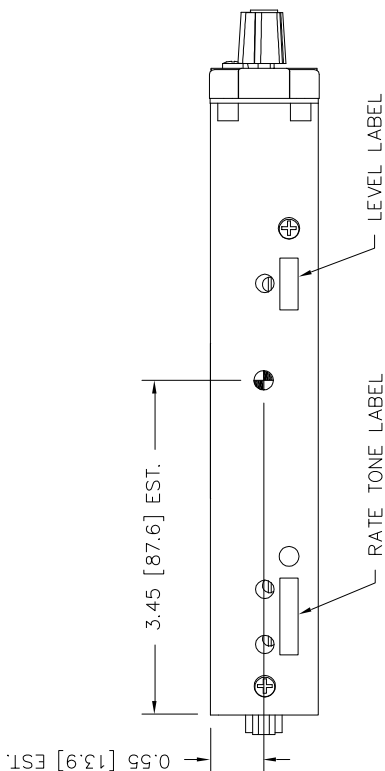
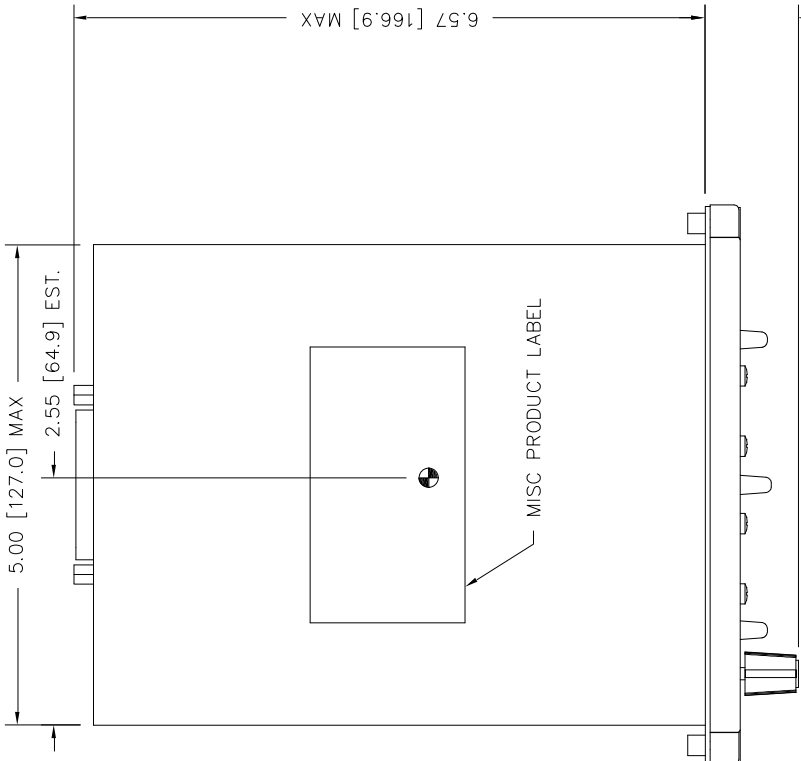

CONFIDENTIAL AND PROPRIETARY TO NAT LTD.

DESIGNED DRAWN	KV	TITLE PA/SIREN SYSTEM				
	TAT					
DATE	SEP 30/03	SIZE	CAGE CODE	PART NO.	REV.	SHEET
CHECKED	NAT 209	A	3AB01	AA22-492	1.00	1/1
APPROVED	NAT 114	DWG. TYPE	MECH. INSTALLATION		DWG. NO.	AA22\492\922-0
FILE	922-0.DWG	FINISH: CHROMATE CONVERSION				

NOTES:
 1. DIMENSIONING AND TOLERANCING
 IN ACCORDANCE WITH ASME Y14.5M-1994

THIRD ANGLE PROJECTION

MASS: 1.10 lbs. (0.5 Kg) MAX
 MATERIAL: -
 FINISH: CHROMATE CONVERSION

nat NORTHERN AIRBORNE TECHNOLOGY LTD.

AA22-493

J101
P101
25 PIN FEMALE DMIN
MATING CONNECTOR

1	+28 VDC POWER
2	+28 VDC POWER
3	+28 VDC LIGHTS
14	POWER GROUND
15	POWER GROUND
16	POWER GROUND
8	SWITCHED POWER OUT
4	N.O. CONTACT
5	WIPER
9	RESERVED
7	AUDIO OUT HI
6	AUDIO OUT HI
19	AUDIO OUT LO
11	RADIO INPUT HI
23	RADIO INPUT LO
12	PA INPUT HI
24	PA INPUT LO
13	MIC INPUT HI
25	MIC INPUT LO
10	SIREN KEY IN
17	SHIELD
18	GROUND
20	GROUND
21	GROUND
22	GROUND

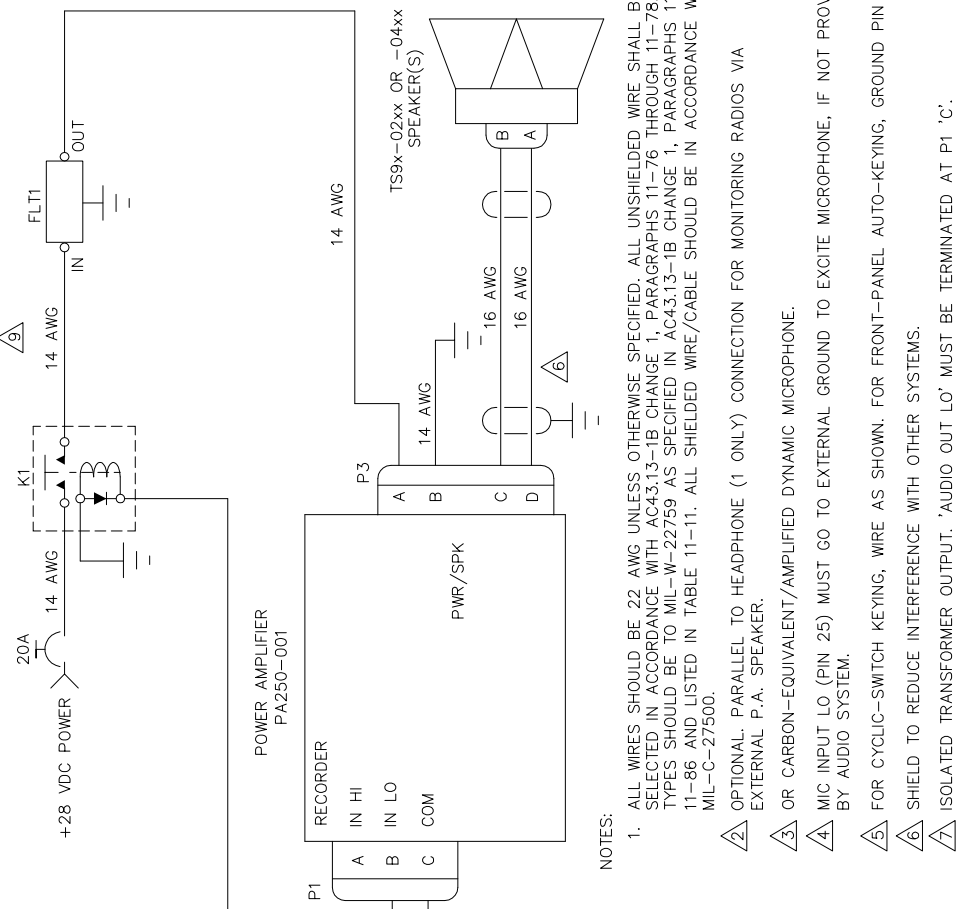
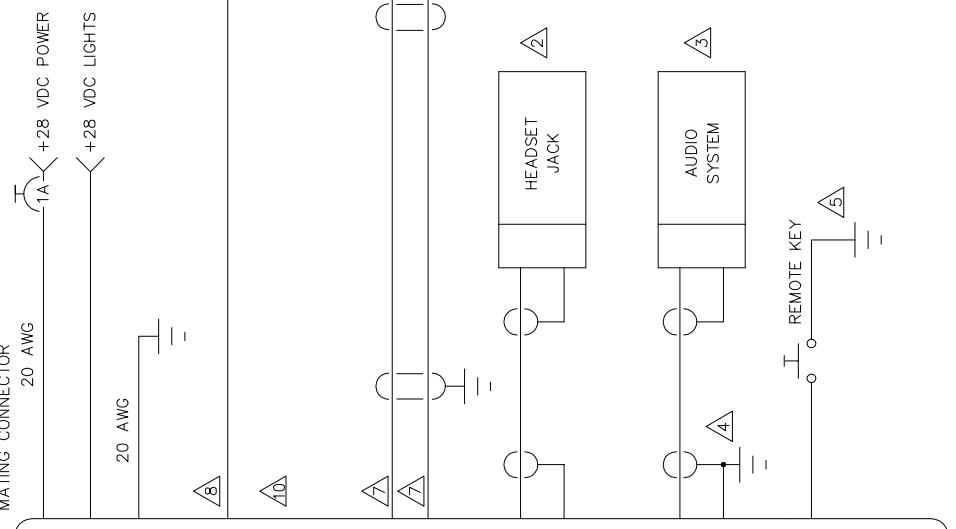

POWER AMPLIFIER
PA250-001

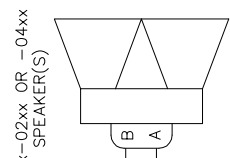

NOTES:

1. ALL WIRES SHOULD BE 22 AWG UNLESS OTHERWISE SPECIFIED. ALL UNSHIELDED WIRE SHALL BE SELECTED IN ACCORDANCE WITH AC43.13-1B CHANGE 1, PARAGRAPHS 11-76 THROUGH 11-78. WIRE TYPES SHOULD BE TO MIL-W-22759 AS SPECIFIED IN AC43.13-1B CHANGE 1, PARAGRAPHS 11-85, 11-86 AND LISTED IN TABLE 11-11. ALL SHIELDED WIRE/CABLE SHOULD BE IN ACCORDANCE WITH MIL-C-27500.
2. OPTIONAL. PARALLEL TO HEADPHONE (1 ONLY) CONNECTION FOR MONITORING RADIOS VIA EXTERNAL P.A. SPEAKER.
3. OR CARBON-EQUIVALENT/AMPLIFIED DYNAMIC MICROPHONE.
4. MIC INPUT LO (PIN 25) MUST GO TO EXTERNAL GROUND TO EXCITE MICROPHONE, IF NOT PROVIDED BY AUDIO SYSTEM.
5. FOR CYCLIC SWITCH KEYING, WIRE AS SHOWN. FOR FRONT-PANEL AUTO-KEYING, GROUND PIN 10.
6. SHIELD TO REDUCE INTERFERENCE WITH OTHER SYSTEMS.
7. ISOLATED TRANSFORMER OUTPUT. 'AUDIO OUT LO' MUST BE TERMINATED AT P1 'C'.
8. SWITCH POWER OUT (PIN 8) RATED 400mA @ 28VDC.
9. K1 RELAY NAT P/N 65-80-200 OR EQUIVALENT. FLT1 RF FILTER NAT/P/N 22-00-0034 OR EQUIVALENT.
10. PINS 4 & 5 ARE RELAY CONTACTS. THE RELAY IS ACTIVE WHEN POWER IS TURNED ON. CONTACTS ARE CONNECTED IN POWER 'ON' STATE.

CONFIDENTIAL AND PROPRIETARY TO NAT LTD.

DESIGNED	RL				
DRAWN	TAT				
DATE	SEP 21/06	TITLE	PA/SIREN SYSTEM 250 WATT		
CHECKED	NAT 231				
APPROVED	NAT 114	SIZE	CAGE CODE	PART NO.	REV. SHEET
FILE	403-1.DWG	A	3AB01	AA22-493	1.00 1/1
		DWG. TYPE	INTERCONNECT	DWG. NO.	AA22\493\403-1

nat NORTHERN AIRBORNE TECHNOLOGY LTD.

Confidential and Proprietary to NAT

J101
MALE 25 PIN D-MIN
CHASSIS CONN.

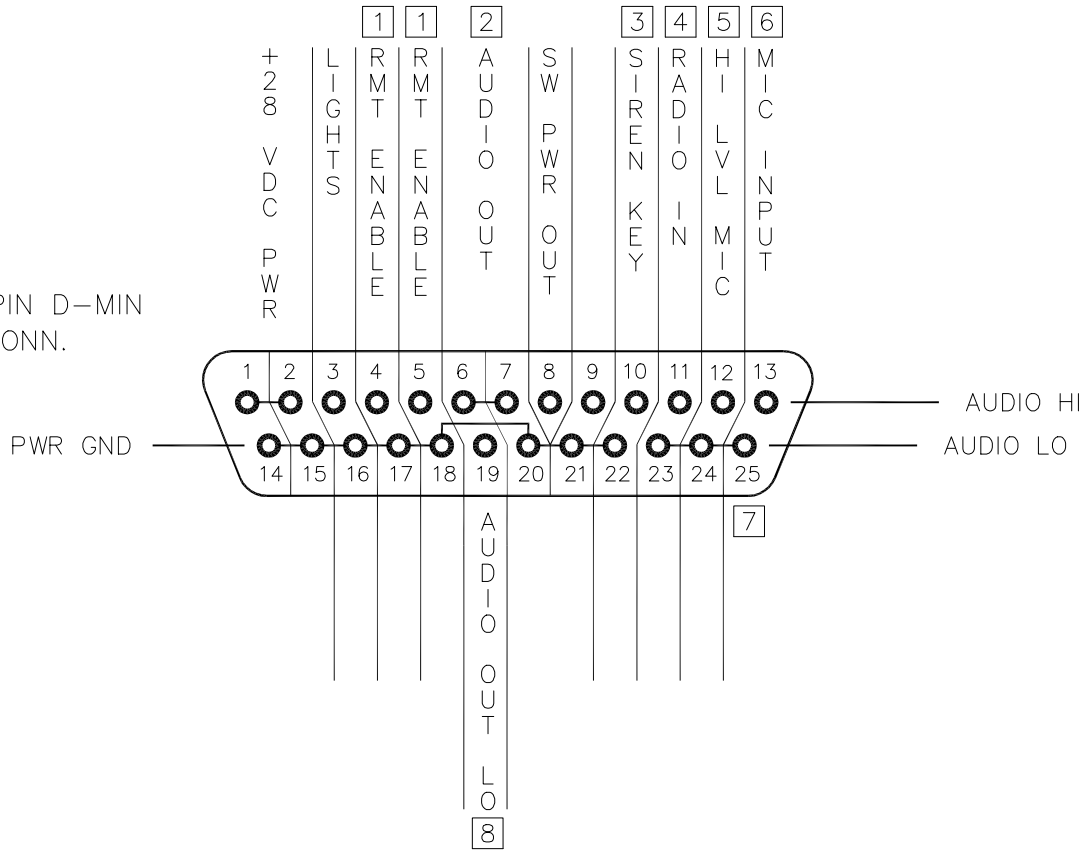

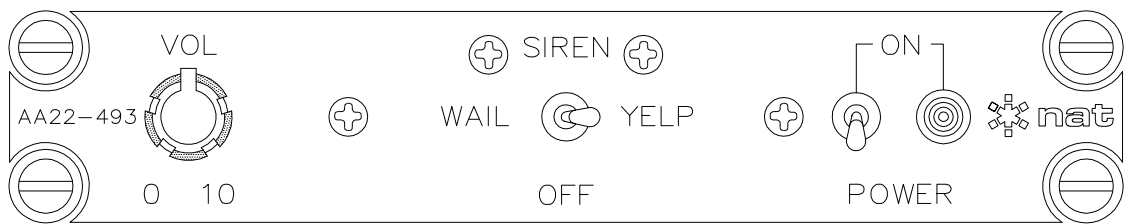

- 1 PINS 4 AND 5 ARE SHORTED ON POWER UP.
- 2 FULL AUDIO OUTPUT TYP. 100mV INTO 100 OHMS.
- 3 GROUNDING PIN 10 WILL TRIGGER SIREN.
- 4 RADIO INPUT TYP. 2.5 V FOR FULL OUTPUT.
- 5 UP TO 5W PA INPUT FROM EXISTING SYSTEM.
- 6 MIC INPUT TYP. 250 mV FOR FULL OUTPUT BIASED.
- 7 MUST GO TO EXTERNAL GROUND TO EXCITE MIC.
- 8 ISOLATED TRANSFORMER OUTPUT. MUST PROVIDE GROUND AT P.A. END.

REVISION	DATE	*nat NORTHERN AIRBORNE TECHNOLOGY LTD.			
1.00	APR 28/95	DESIGNED BY	DESCRIPTION		
1.01	FEB 14/96	KV	PA/SIREN SYSTEM		
		DRAWN BY	PART NUMBER	DRAWING TYPE	SHEET
		M. SAWCHUK	AA22-493	CONNECTOR MAP	1/1
		APPROVED BY	DRAWING NUMBER	FILE NUMBER	
		NAT 107	AA22\493\405-0	AA22\493\405-0101	





Confidential and Proprietary to NAT

DESIGNED	KV	 NORTHERN AIRBORNE TECHNOLOGY LTD.				
DRAWN	TGM					
DATE	MAR 25/97	TITLE PA/SIREN SYSTEM				
CHECKED	NAT PROD. 105					
APPROVED		SIZE A	CAGE CODE 3AB01	PART NO. AA22-493	REV. 1.00	SHEET 1/2
FILE	905-0100.DWG	DWG. TYPE	FACEPLATE	DWG. NO. AA22\493\905-0		

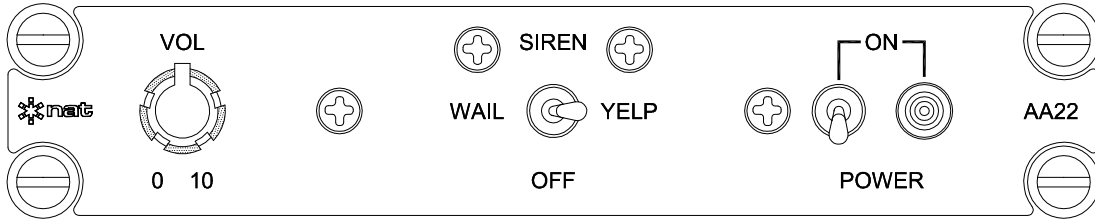
REVISIONS			
REV	DESCRIPTION	DATE	BY
1.10	ECR #1079 - REMOVED "-493". DOCCR01656 - FORMAT CHANGES.	APR 15/08	MWS



CONFIDENTIAL AND PROPRIETARY TO NAT LTD.

DESIGNED	KV	 NORTHERN AIRBORNE TECHNOLOGY LTD.					
DRAWN	TGM						
DATE	APR 15/08	TITLE PA DRIVER/SIREN SYSTEM FRONT VIEW					
CHECKED							
APPROVED		SIZE A	CAGE CODE 3AB01	PART NO. AA22-493	REV. 1.10	SHEET 1/3	
FILE	905-0.DWG	DWG. TYPE	FACEPLATE	DWG. NO.	AA22\493\905-0		



AA22 Series PA Driver/Siren Control SM33-2 Installation and Operation Manual

Section 3 Operation

3.1 Introduction

Information in this section consists of functional and operational procedures for the AA22 Series PA Driver/Siren Control.

3.2 General Information

The AA22 PA Driver/Siren Control provides a central adjustment for external aircraft loudhailer functions. The AA22 is only a line driver and must have at least one external amplifier in the system. When turned on, the system is ready for operation and will accept audio feeds or a microphone input. An internally generated siren is also available and adjustable through the side of the controller. When the AA22 is turned on, a 'POWER KEY' signal is generated. This signal is used to turn on the 'PA' amp. The high current DC to operate the PA110/220 is supplied by the aircraft.

3.3 Controls and Indicators

3.3.1 Power Up

To activate the AA22 PA Driver/Siren Control, flip the POWER toggle switch up, to the ON position. The LED adjacent to the switch should illuminate.

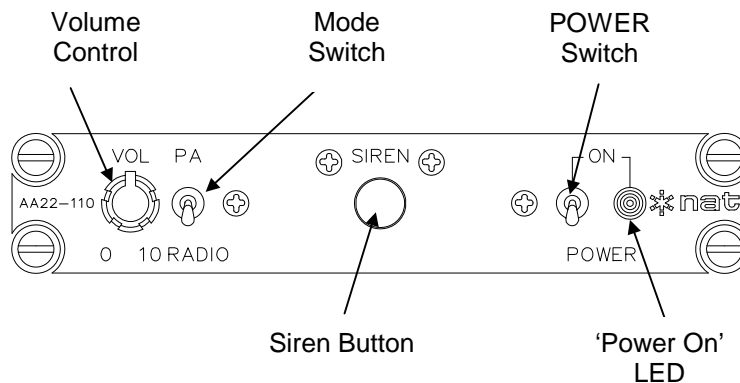

3.3.2 Mode Switch

The Mode switch is a two-position toggle switch used to select between PA and Radio operation.

3.3.2.1 PA Operation

For external loudhailer systems, set the Mode switch on the AA22 to PA. Key the microphone through the cyclic switch or hand mic switch, and speak in a firm, clear manner. For best results, over-emphasize each word.



AA22 Series PA Driver/Siren Control SM33-2 Installation and Operation Manual

3.3.2.2 Radio Operation

To set the system for radio rebroadcast functions, set the Mode switch on the AA22 to RADIO. All audio delivered from the source (typically pilot's or copilot's headset) will be broadcast through the PA system, if provision for this is made at the time of installation.

3.3.3 Volume Control

The VOL control pot on the front of AA22 sets the volume level. For external loudhailer and rebroadcast operations, the volume should always be set between half and full level.

3.3.4 Siren Button

3.3.4.1 AA22-110

The siren is activated by depressing the momentary push-button SIREN control on the front of the AA22, or by using a remote keying switch. The siren will sound only as long as the button is depressed. Level setting is automatic and need not be adjusted.

3.3.4.2 AA22-160, AA22-492 and AA22-493

On these models, the front-panel SIREN button is replaced by a WAIL/OFF/YELP switch. This allows the operator to disable the siren, or select the required siren mode from the front panel of the AA22.

3.3.5 Remote Power Switch

Remote power switching for the power amplifiers is provided as a switched +28 Vdc output from the AA22.

Section 3 ends
