

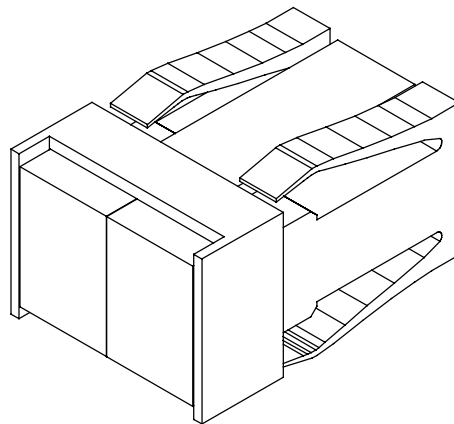

Part of  
**SM15**

**LL08  
Legend Lamp**



## **INSTALLATION AND OPERATION MANUAL**

**REV 4.00 November 24, 2003**

**Northern Airborne Technology Ltd.  
1925 Kirschner Road  
Kelowna BC, Canada  
V1Y 4N7**

**Telephone (250) 763-2232  
Facsimile (250) 762-3374**

**Copyright 2003 by Northern Airborne Technology**







**Table of Contents**

| <b>Section</b> | <b>Title</b>                    | <b>Page</b> |
|----------------|---------------------------------|-------------|
| 1.0            | Description                     |             |
| 1.1            | Introduction                    | 1-1         |
| 1.2            | Purpose of Equipment            | 1-1         |
| 1.3            | Features                        | 1-1         |
| 1.4            | Specifications                  | 1-1         |
| 1.4.1          | Electrical Specifications       | 1-1         |
| 1.4.2          | Physical Specifications         | 1-1         |
| 1.5            | Unit Nomenclature               | 1-2         |
| 1.5.1          | Replacement Filter Part Numbers | 1-2         |
| 2.0            | Installation                    |             |
| 2.1            | Introduction                    | 2-1         |
| 2.2            | Unpacking and Inspection        | 2-1         |
| 2.3            | Installation Procedures         | 2-1         |
| 2.3.1          | Cautions                        | 2-1         |
| 2.3.2          | Notes                           | 2-1         |
| 2.3.3          | Installing the Legends          | 2-1         |
| 2.3.4          | Changing Lamps                  | 2-2         |
| 2.4            | Continued Airworthiness         | 2-2         |
| 2.5            | Drawings                        | 2-2         |



## Section 1.0 Description

### 1.1 Introduction

---

This manual contains information on the LL08 Legend Lamp.

Information in this section consists of purpose of equipment, features and specifications.

### 1.2 Purpose of Equipment

---

The LL08 is a two-section legend lamp with changeable legends. It is designed for use with the RS series of remote switches from NAT.

### 1.3 Features

---

Styled to look the same as its companion illuminated switch, the PB08, the LL08 allows a clean, integrated panel appearance. Two independent lamps are included in the LL08, each with isolated terminals.

It is shipped assembled (but with no legends inserted) and with 28 V lamps installed. The desired legends must be cut from the sheet provided and inserted inside the lens cap. If 14 V operation is required, substitute type 386 lamps.

### 1.4 Specifications

---

#### 1.4.1 Electrical Specifications

---

|             |  |
|-------------|--|
| Input Power | +14/+28 Vdc at 200 mA max.                                     |
| Lamps       | Type 388 for 28 Vdc operation<br>Type 386 for 14 Vdc operation |

#### 1.4.2 Physical Specifications

---

|                      |  |
|----------------------|--|
| Height               | 0.71 inches (17.9 mm)                                |
| Length               | 1.33 inches (33.8 mm)                                |
| Width                | 0.94 inches (23.8 mm)                                |
| Mounting             | Front mounting, held in place by compression fingers |
| Mounting hole height | 0.59 inches (14.9 mm)                                |
| Mounting hole width  | 0.82 inches (20.8 mm)                                |

## 1.5 Unit Nomenclature

---

The following list indicates the models available at the date of publication of this document. Other models may be available.

| Model    | Description / Distinction  |
|----------|--|
| LL08-001 | 2 section legend lamp<br>Amber/Red segments with changeable legends and lamps<br>(28 Vdc lamps supplied)<br>Matches PB08 in appearance<br>Supplied with assorted legends |
| LL08-002 | Identical to the LL08-001 but with Amber/Amber segments  |
| LL08-003 | Identical to the LL08-001 but with Blue/Green segments   |
| LL08-004 | Identical to the LL08-001 but with Green/Green segments  |
| LL08-005 | Identical to the LL08-001 but with Amber/Green segments  |
| LL08-006 | Identical to the LL08-001 but with Clear/Clear segments  |
| LL08-007 | Identical to the LL08-001 but with Red/Red segments  |

### 1.5.1 Replacement Filter Part Numbers

---

| Filter Colour             | NAT Part # |
|---------------------------|------------|
| Illuminated Filter, Amber | 85-82-004  |
| Illuminated Filter, Green | 85-82-005  |
| Illuminated Filter, Blue  | 85-82-006  |
| Illuminated Filter, Red   | 85-82-007  |
| Illuminated Filter, Clear | 85-82-008  |
| Lens holder (Diffuser)    | 85-82-001  |

End of section 1.0

## Section 2.0 Installation

### 2.1 Introduction

---

Information in this section consists of unpacking and inspection procedures, installation procedures, post-installation checks, and installation drawings.

### 2.2 Unpacking and Inspection

---

Unpack the unit and inspect visually for damage due to shipping and report all such claims immediately to the carrier involved. Note that each unit should have the following:

- LL08 Legend Lamp
- Two transparent 'Legend' sheets
- Installation Manual

Verify that all items are present before proceeding and report any shortage immediately to your supplier.

### 2.3 Installation Procedures

---

#### 2.3.1 Cautions

---

The lens assembly fits in the housing with either colour to the right, so to ensure correct wiring follow the drawings in Section 2.5.

#### 2.3.2 Notes

---

Other lens combinations are available from NAT, or they can be interchanged with legends from the PB08.

#### 2.3.3 Installing the Legends

---

To install the required legends into the LL08, first examine the legends supplied, and pick out the combination that is most suitable for your application. Note that both horizontal and vertical legends are provided. If used for warning/alert indications, the RED legend is warning, and the AMBER legend is alert.

Cut the legends along the border line and then into two individual sections using a pair of sharp scissors. Withdraw the lens/diffuser assembly from the switch body by gripping the lens cap on the provided notches and pulling out. A slight rocking motion will make it easier. Pop the lenses off the diffuser and insert the legends of your choice, making sure they are adequately trimmed and square. Replace the lenses, then push the whole assembly back into the switch body. When it is firmly seated, it will lock into place.

### 2.3.4 Changing Lamps

---

To replace or change lamps, withdraw the lens/diffuser assembly and pull out the lamp with a pair of needle-nosed pliers. Push in a new lamp and press down on the top of the lamp with the end of a pencil eraser or other object until the lamp clicks into place. When it is correctly seated, it will not move farther in. Replace the lens assembly.

### 2.4 Continued Airworthiness

---

---

Maintenance of this product is on condition only. Periodic maintenance of this product is not required.

### 2.5 Drawings

---

---

| DRAWING        | REV. | DESCRIPTION      | TYPE               |
|----------------|------|------------------|--------------------|
| LL08\904-0     | 1.10 | LL08 Legend Lamp | Exploded View      |
| LL08\922-0     | 1.02 | LL08 Legend Lamp | Mech. Installation |
| LL08\001\701-0 | 1.10 | LL08 Legend Lamp | Parts List         |

Section 2.0 ends after these Drawings

| REVISIONS |                          |           |     |
|-----------|--------------------------|-----------|-----|
| REV       | DESCRIPTION              | DATE      | BY  |
| 1.01      | FORMAT CHANGES           | JUL 14/95 | PL  |
| 1.10      | CORRECTIONS, NEW LEGENDS | OCT 18/96 | TGM |

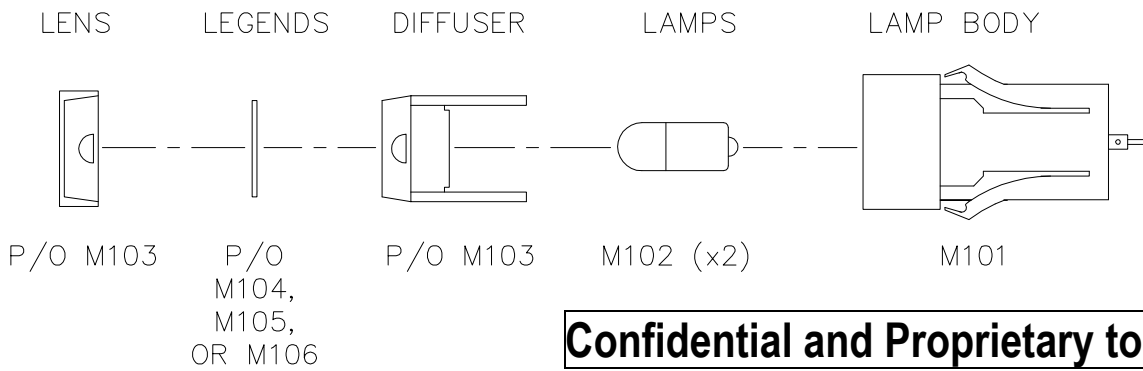

**Confidential and Proprietary to NAT**

AVAILABLE LEGENDS

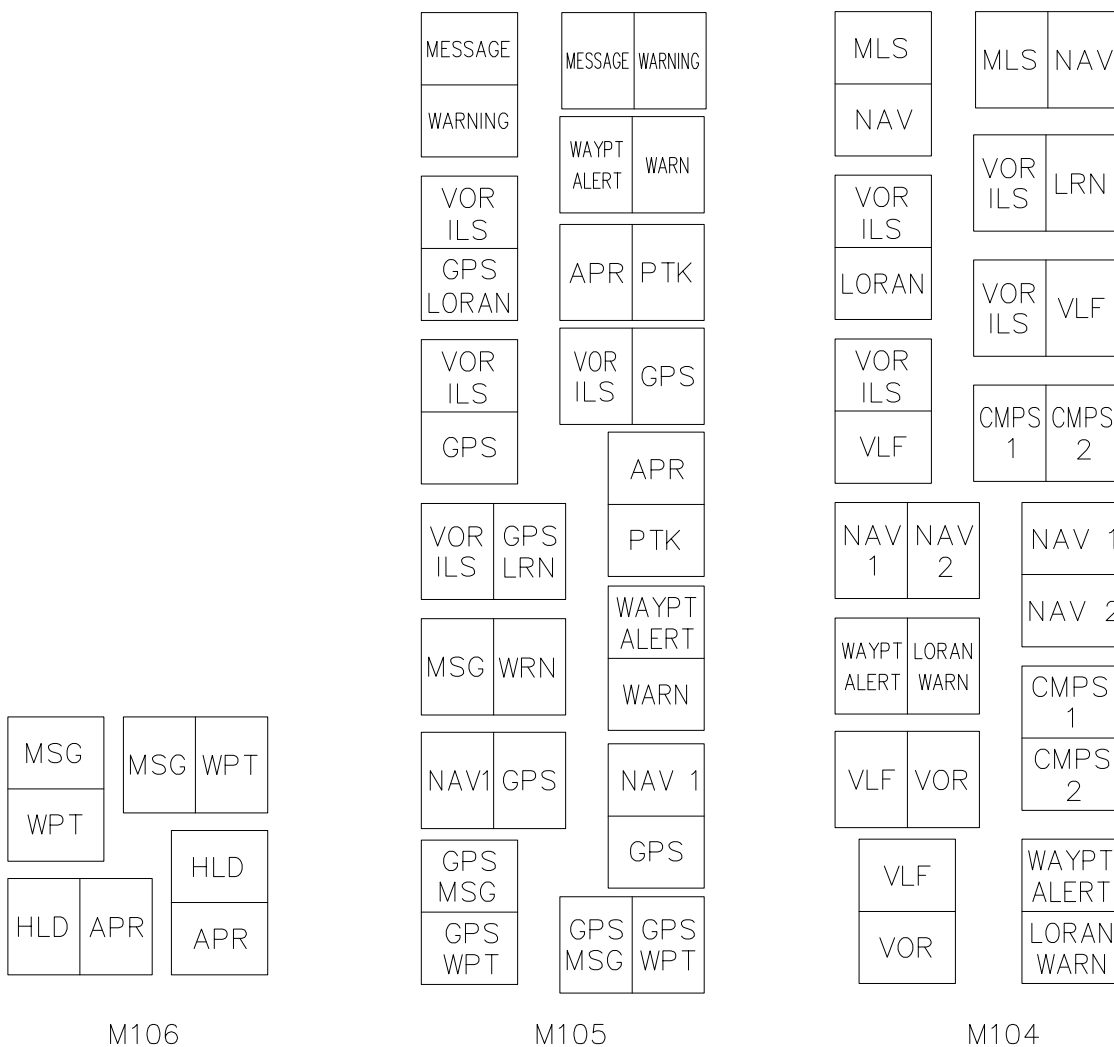

|          |              |  |               |          |            |       |
|----------|--------------|--|---------------|----------|------------|-------|
| DESIGNED | KV           | <b>NAT</b> NORTHERN AIRBORNE TECHNOLOGY LTD. |               |          |            |       |
| DRAWN    | KV           |  |               |          |            |       |
| DATE     | APR 18/86    | TITLE  |               |          |            |       |
|          |              | LEGEND LAMP                                  |               |          |            |       |
| CHECKED  |              | SIZE   | CAGE CODE     | PART NO. | REV.       | SHEET |
| APPROVED |              | A  | 3AB01         | LL08     | 1.10       | 1/1   |
| FILE     | 904-0110.DWG | DWG. TYPE                                    | EXPLODED VIEW | DWG. NO. | LL08\904-0 |       |



| REVISIONS |                                    |           |     |
|-----------|------------------------------------|-----------|-----|
| REV       | DESCRIPTION                        | DATE      | BY  |
| 1.01      | FORMAT CHANGES                     | JUL 14/95 | PL  |
| 1.02      | CORRECTIONS AND DWG NUMBER CHANGED | OCT 18/96 | TGM |

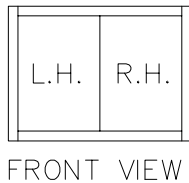
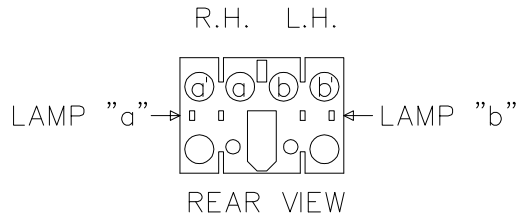

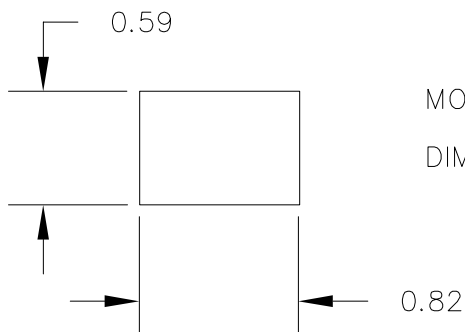

NORMALLY SUPPLIED WITH TYPE 388 LAMP (28V)

USE TYPE 386 LAMP FOR 14V OPERATION



MOUNTING HOLE:  
DIMENSIONS ARE IN INCHES

**Confidential and Proprietary to NAT**

|          |   |  |                    |                  |              |              |
|----------|---|--|--------------------|------------------|--------------|--------------|
| DESIGNED | KV  |  <b>NAT</b> NORTHERN AIRBORNE TECHNOLOGY LTD. |                    |                  |              |              |
| DRAWN    | KV  |  |                    |                  |              |              |
| DATE     | APR 18/86   | TITLE<br>LEGEND LAMP   |                    |                  |              |              |
| CHECKED  |  |  |                    |                  |              |              |
| APPROVED |  | SIZE<br>A  | CAGE CODE<br>3AB01 | PART NO.<br>LL08 | REV.<br>1.02 | SHEET<br>1/1 |
| FILE     | 922-0102.DWG  | DWG. TYPE  | MECH. INSTALLATION | DWG. NO.         | LL08\922-0   |              |





# PARTS LIST

NAT Part #: **LL08-001 thru -007**

Description: **Legend Lamp**

Document #: **LL08\001\701-0**

Rev: **1.10**

Prepared By:

**NAT**  
**214**

Checked By:

**NAT**  
**104**

Approved By:

**NAT**  
**107**

| <u>IDENT</u>                   | <u>DESCRIPTION</u>                       | <u>MFR. P/N</u><br><u>OR VALUE</u> | <u>PACKAGE</u> | <u>NAT P/N</u> | <u>QTY.</u> |
|--------------------------------|--|------------------------------------|----------------|----------------|-------------|
| <b><u>MECHANICAL PARTS</u></b> |  |                                    |                |                |             |
| M101                           | Push Button, Unlimited                   |                                    |                | 85-57-040      | 1           |
| M102                           | Lamp *                                   | 28 Vdc                             | T1-3/4         | 45-01-388      | 2           |
| M103                           | Red/Amber Lens Assembly**                |                                    |                | 85-82-040      | 1           |
| M104                           | Legend and Template, Transparent Plastic |                                    |                | 43-10-108      | 1           |
| M105                           | Legend and Template, Transparent Plastic |                                    | 43-10-208      | 1              |             |
| M106                           | Legend and Template, Transparent Plastic |                                    | 43-10-308      | 1              |             |

\* Can be replaced with:

|      |      |        |        |           |  |
|------|------|--------|--------|-----------|--|
| M102 | Lamp | 14 Vdc | T1-3/4 | 45-01-386 |  |
|------|------|--------|--------|-----------|--|

\*\* For other models replace with:

### LL08-002

|       |  |  |  |           |   |
|-------|--|--|--|-----------|---|
| M103A | Lens Holder                            |  |  | 85-82-001 | 1 |
| M103B | Push Button, Illuminated Filter, Amber |  |  | 85-82-004 | 2 |

### LL08-003

|       |                   |  |  |           |   |
|-------|-------------------|--|--|-----------|---|
| M103A | Lens, Blue/ Green |  |  | 85-82-461 | 1 |
|-------|-------------------|--|--|-----------|---|

### LL08-004

|       |  |  |  |           |   |
|-------|--|--|--|-----------|---|
| M103A | Lens Holder                            |  |  | 85-82-001 | 1 |
| M103B | Push Button, Illuminated Filter, Green |  |  | 85-82-005 | 2 |

### LL08-005

|       |  |  |  |           |   |
|-------|--|--|--|-----------|---|
| M103A | Lens Holder                            |  |  | 85-82-001 | 1 |
| M103B | Push Button, Illuminated Filter, Amber |  |  | 85-82-004 | 1 |
| M103C | Push Button, Illuminated Filter, Green |  |  | 85-82-005 | 1 |

### LL08-006

|       |                   |  |  |           |   |
|-------|-------------------|--|--|-----------|---|
| M103A | Lens, Clear/Clear |  |  | 85-82-011 | 1 |
|-------|-------------------|--|--|-----------|---|

### LL08-007

|       |                                      |  |  |           |   |
|-------|--------------------------------------|--|--|-----------|---|
| M103A | Lens Holder                          |  |  | 85-82-001 | 1 |
| M103B | Push Button, Illuminated Filter, Red |  |  | 85-82-007 | 2 |

End of parts list

**Confidential and Proprietary to NAT**

