



SM09-2A

AA83-001

**InterMUSIC™ Stereo Intercom System
Serial No. 2939 and later**



INSTALLATION AND OPERATION MANUAL

REV 4.00 February 8, 2006

Northern Airborne Technology Ltd.
1925 Kirschner Road
Kelowna, BC, Canada.
V1Y 4N7

Telephone (250) 763-2232
Facsimile (250) 762-3374

Copyright 2006 by Northern Airborne Technology

Table of Contents

Section	Title	Page
1	Description	
1.1	Introduction	1-1
1.2	Purpose of Equipment	1-1
1.3	Features	1-1
1.3.1	Stereo & Intercom Special Features	1-1
1.3.2	Communication Functions	1-1
1.4	Specifications	1-2
1.4.1	Electrical Specifications	1-2
1.4.2	Physical Specifications	1-4
1.4.3	Environmental Specifications	1-4
2	Installation	
2.1	Introduction	2-1
2.2	Unpacking and Inspection	2-1
2.2.1	Warranty	2-1
2.3	Installation Procedures	2-1
2.3.1	Warnings	2-1
2.3.2	Cautions	2-2
2.3.3	Cabling and Wiring	2-2
2.3.4	Adjustments	2-3
2.3.5	Mechanical Installation	2-3
2.3.6	Post-Installation Checks	2-5
2.4	Continued Airworthiness	2-6
2.5	Accessories Supplied	2-7
2.6	Installation Drawings	2-7
3	Operation	
3.1	Introduction	3-1
3.2	General Operation	3-1
3.2.1	Stereo & Intercom Special Features	3-1
3.2.2	Communication Functions	3-1
3.2.3	Important Operating Considerations	3-2
3.2.4	Installation Adjustments	3-2
3.3	Controls and Indicators	3-2
3.3.1	ICS VOL/PILOT VOX	3-2
3.3.2	MUSIC VOL/COPILOT VOX	3-3
3.3.3	VOX Operation	3-3

Section	Title	Page
3.3.4	Annunciator	3-3
3.3.5	MODE Control	3-4
3.3.6	Radio Functions	3-5
3.3.7	Muting Logic	3-5
3.3.8	Automatic Fail-safe	3-6

Section 1 Description

1.1 Introduction

This manual contains information on the AA83-001 InterMUSIC™ Stereo Intercom System serial numbers 2939 and later. All derivative products will be covered by manual supplements, which can be obtained from NAT as required.

Information in this section consists of purpose of equipment, features and specifications.

1.2 Purpose of Equipment

The AA83-001 is a 4-place stereo voice-activated intercom, providing full intercom capabilities for pilot, copilot and two passengers (PAX). The AA83-001 has a built-in tieline with tie/split capability, providing support for additional users in a multi-unit system.

The AA83-001 also provides transmit capability for pilot and co-pilot to a single COM radio or audio selector panel. The AA83-001 accepts stereo music inputs from either portable or fixed entertainment systems to produce high quality stereo headset output.

1.3 Features

1.3.1 Stereo & Intercom Special Features

The stereo music audio is muted during transmit or intercom operation and when radio receive audio is detected, permitting greater intelligibility of incoming transmissions.

The AA83-001 muting depth adjustment ranges from complete music muting to gentle background music on command, with a fast attack and slow level return for optimum user comfort.

Each microphone is individually gated, for the best possible noise performance during VOX operation. A front panel annunciator allows easy visual setting of the VOX threshold, and also indicates transmit operation.

1.3.2 Communication Functions

The AA83-001 provides full boom-mic transmit and ICS functions for the pilot and co-pilot, and provides ICS and radio monitor operation for two additional passengers. Pilot priority on transmit and pilot isolation/fail-safe (direct connection to the aircraft radio system) are standard features on all NAT intercom systems. The AA83-001 can support PTT ICS operation for all users, and can be wired to cyclic/yoke switches for both TX and ICS functions.

1.4 Specifications

1.4.1 Electrical Specifications

<u>Input Power</u>	Linear regulator with over voltage protection
Operating Voltages:	
Nominal	27.5 or 13.8 Vdc @ 550 mA max (one input for both)
Maximum	30.3 Vdc
Minimum	11.0 Vdc
Internal supply	11 Vdc

Input Signals

Microphone

Quantity	4 (Pilot, Co-pilot, 2 Passengers).
Rated level	250 mVrms nominal (125 to 500 mVrms)
Impedance	150 Ohm ± 10 %
Circuitry type	unbalanced

TX Keyline

Quantity	2 (Pilot, Co-pilot).
Rated level	ground activates keyline, <20 mA source current

ICS Keyline

Quantity	4 (Pilot, Co-pilot, 2 Passengers).
Rated level	ground activates keyline, <1 mA source current

Receive Audio

Quantity	1
Rated level	2.5 Vrms nominal (1.3 to 5.0 Vrms)
Impedance	1.2 kOhm ± 20 %
Circuitry type	unbalanced

Music Inputs

Quantity	2 (left channel, right channel)
Rated level	1.4 Vrms nominal (850 mVrms to 2.4 Vrms)
Impedance	12.5 kOhm ± 10 %
Circuitry type	unbalanced

Bidirectional Signals

ICS TIE Channel

Quantity	1
Rated level	340 mVrms nominal (170 to 680 mVrms)
Impedance	2 kOhm ± 10 %
Circuitry type	unbalanced

Output Signals

Phones

Quantity	4 (Pilot, Co-pilot, 2 Passengers)
Rated level	>5.5 Vrms (>100 mW, RX and ICS and music)
Impedance	300 Ohm \pm 10 %
Circuitry type	transformer, unbalanced

Radio TX Mic

Quantity	1
Rated level	250 mVrms \pm 10 %
Impedance	150 Ohm nominal
Circuitry type	direct throughline via relay

Radio TX Keyline

Quantity	1
Rated level	<1 A
Circuitry type	grounded relay contact

Audio Performance

Per RTCA DO-170 except where noted. Product Classification: 1a

Rated Output Power	100 mW min. into 300 Ω (each stereo channel)
Audio freq. response	
Receive	\leq 3dB down from 350 - 6000 Hz
Intercom	\leq 3dB down from 350 - 3000 Hz
ICS Tie	\leq 3dB down from 350 - 3000 Hz
Music	\leq 3dB down from 300 - 15000 Hz (Music Bass control at mid setting)
Distortion	\leq 10%, \leq 3% typical (350 to 6000 Hz)
Input - Input crosstalk	-50 dB max*
Input - Output crosstalk	-55 dB max.
Input - Mic crosstalk	<1.0 mVrms*
Audio noise	-50 dB max
Output Regulation	\leq 3 dB variance (350 to 6000 Hz)
Audio Communication	Loud & Clear
ICS Volume control	\geq 35 dB*, 40 dB nominal
Music Volume control	\geq 35 dB*, 40 dB nominal
Amplifiers with Compression	N/A
Stability and Short Circuit Protection	No spurious or sustained oscillations.
Receive Input impedance	1.2 k Ω \pm 20%
Mic Input impedance	150 Ω \pm 10%
Music Input impedance	12.5 k Ω \pm 10 %
Tie Line	2 k Ω \pm 10 %

Note: * Denotes manufacturer's specification

Miscellaneous Audio Performance

ICS BAL control:	≥20 dB dynamic range
MUS BAL control:	≥20 dB dynamic range
RX BAL control:	≥20 dB dynamic range
ICS BASS control:	±2.5 dB min. range at 350 Hz*
MUS BASS control:	±2.5 dB min. range at 350 Hz*
MUS MUTE control:	-60 dB to -10 dB
Music attack/decay time:	< 7 seconds
RX volume control:	≥35 dB dynamic range

* measured at -10 dB ref: rated input level.

1.4.2 Physical Specifications

Height	1.32" (33.5 mm) max
Depth	7.20" (182.9 mm) max 5.84" (148.3 mm) max behind panel
Width	2.62" (66.5 mm) max panel width
Weight	0.70 lbs (0.32 kg) max
Mounting	Through front panel; three 6-32 black brass screws. Aircraft panel thickness 0.050" to 0.125"
Faceplate	Panel is a rectangular double-sided photo-imaged 0.062" aluminum plate, 1.32" high x 2.62" wide, max
Material/Finish	Chassis and Cover: Brushed aluminum with chromate conversion
Connectors	One 44 pin male high-density D-min connector with jackposts
Installation Kit	AA83-IKC

1.4.3 Environmental Specifications

Temperature	-20° to +55° C
Altitude	50,000 ft
Shock	6g/11ms, 20g/11ms, 20g/3s sustained.

Qualification:

DO-160D Env. Cat. [(A1)(D1)X]BXB[(SMB)(UF)]XXXXXXZBAXXXMXXXX
 Safety of Flight requirements per RTCA DO-160D Environmental Conditions.

End of section 1

Section 2 Installation

2.1 Introduction

Information in this section consists of unpacking and inspection procedures, installation procedures, post-installation checks, and installation drawings for the AA83-001 InterMUSIC™ Stereo Intercom, serial numbers 2939 and later.

2.2 Unpacking and Inspection

Unpack the equipment carefully and locate the warranty card. Inspect the unit visually for damage due to shipping and report all such claims immediately to the carrier involved. Note that each unit should have the following:

- AA83-001 InterMUSIC™ Stereo Intercom
- Installation kit (see section 2.5)
- Warranty Card
- Operator's Manual
- Release certification

Verify that all items are present before proceeding and report any shortage immediately to your supplier.

2.2.1 Warranty

Complete the warranty card information and send it to NAT when the installation is complete. If you fail to complete the warranty card, the warranty will be activated on date of shipment from NAT.

Note: An appropriately rated facility, e.g. Certified Aircraft Repair Station, must install this equipment in accordance with applicable regulations. NAT Ltd's warranty is not valid unless the equipment is installed by an authorized NAT Dealer. Failure to follow any of the installation instructions, or installation by a non-certified individual or agency will void the warranty, and may result in a non-airworthy installation.

2.3 Installation Procedures

2.3.1 Warnings

**High volume settings can cause hearing damage.
Set the headset volume control to the minimum volume
setting prior to conducting audio tests, and slowly increase
the headset volume to a comfortable listening level.**

2.3.2 Cautions

Do not bundle **any lines from this unit** with transmitter coax lines. Do not bundle any logic, audio, or DC power lines from this unit with 400 Hz synchro wiring or AC power lines. Do not position this unit next to any device with a strong alternating magnetic field such as an inverter, motor or blower, or significant audio interference will result.

In all installations, use shielded cable exactly as shown and **ground as indicated**. Significant problems may result from not following these guidelines.

All audio installations can be seriously degraded by incorrect wiring and shielding, and may result in abnormal cross-talk, hum and ground-loop noise. Be especially careful with all microphone wiring and Tie Line wiring, as these lines carry the lowest level signals in the aircraft.

All microphone and headset jacks should be electrically isolated from the airframe or significant ground loop noise may result.

2.3.3 Cabling and Wiring

All unshielded wire shall be selected in accordance with AC43.13-1B Change 1, Paragraphs 11-76 through 11-78. Wire types should be to MIL-W-22759 as specified in AC43.13-1B Change 1, Paragraphs 11-85, 11-86, and listed in Table 11-11. For shielded wire applications, use Tefzel MIL-C-27500 shielded wire with solder sleeves (for shield terminations) to make the most compact and easily terminated interconnect. Follow the wiring diagrams in Section 2.6 as required.

Allow 3 inches from the end of the wire to the shield termination to allow the hood to be easily installed. Note that the hood is a 'clamshell' hood, and is installed after the wiring is complete. Aircraft harnessing should permit the unit to be lowered from the panel for easy access to all side adjustments. Do NOT mount the unit until all adjustments have been carried out.

All wiring should be at least 22 AWG. Ensure that all ground connections are clean and well secured, and that they share no path with any electrically noisy aircraft accessories such as blowers, turn and bank instruments or similar loads. Power to this unit must be supplied from a separate breaker (1 A) or fuse (1 A fast), and not attached to any other existing breaker without additional protection. The correct fuse is included with the AA83.

Ensure that all ground connections are clean and well secured.

2.3.4 Adjustments

The unit ships from the factory with all internal adjustments set to the normal test levels. Once installed in the aircraft, it may be desirable to change some of these settings to best suit the local operating environment.

CAUTION

Before performing the following adjustments ensure the aircraft radio's volume control is set to produce 2.5 Vrms $\pm 10\%$ at the input to the AA83-001, or the mute functions may not operate correctly.

The internal adjustments are located along the sides of the unit and are as follows:

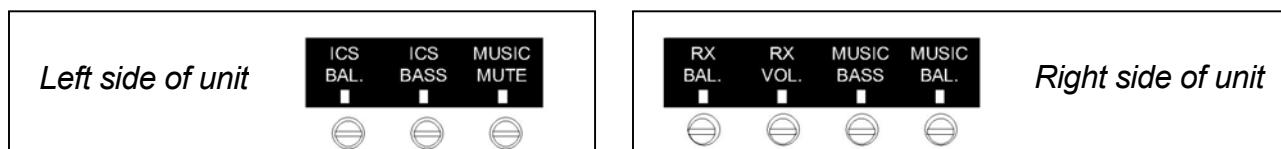

2.3.4.1 ICS, RX, and MUSIC BAL.

These potentiometers are used to adjust the headset stereo balance.

2.3.4.2 ICS and MUSIC BASS

These potentiometers are used to adjust the amount of bass audio to the headsets. Rotating ccw will lower the bass level, and cw will raise it.

2.3.4.3 RX VOL

To reduce the receive audio volume, rotate this potentiometer ccw, and to increase the volume, rotate it cw.

2.3.4.4 MUSIC MUTE

The music mute level can be adjusted using this potentiometer.

2.3.5 Mechanical Installation

Before the unit is mounted, make all functional tests and trimpot adjustments. Be sure the harness has enough clearance to permit the unit to be dropped down for re-adjustment, if needed later. Make sure unit is securely fastened to the panel, and that the connector locks are tightened **before any flight is attempted**.

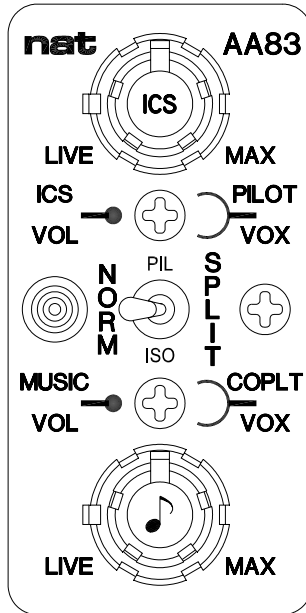

The AA83-001 can be installed in a vertical or horizontal attitude directly on the instrument console, using the AA83-IKC Installation kit (see Section 2.5 for details).

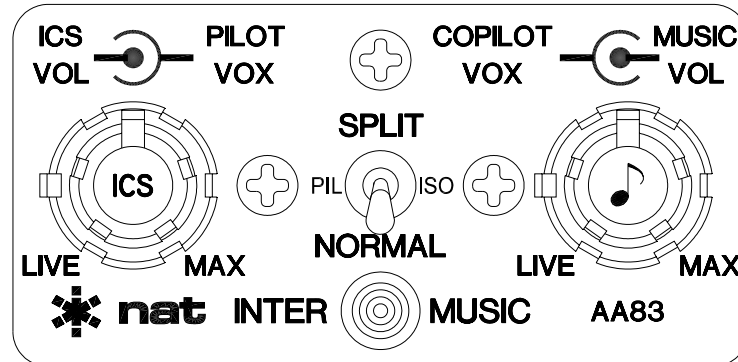

For proper installation, refer to **Mounting Diagram** (AA83\001\920-0) and **Drill Template** (AA83\001\921-0) and the following steps:

Note: The mounting nuts on the panel pots should not be removed at any time.

- a) After deciding the attitude (vertical or horizontal) of the unit, drill the required mounting holes in the aircraft panel and insert the AA83-001 from behind the panel.
- b) Remove the protective plastic film from the black metal faceplate, and position it with the appropriate legend orientation facing out. Secure with the mounting screws provided.

Note: Ensure that the aircraft panel is tightly 'sandwiched' between the AA83-001 and faceplate.

- c) Rotate the inner and outer shafts of the ICS VOL / VOX potentiometer fully ccw. The outer knob may be rotated by hand, but it may be necessary to temporarily attach the inner ICS knob to facilitate this action. Align the white markers on the knobs (part of 40-21-ICS3) to the LIVE position on the faceplate label. Using a 0.05" Allen key, tighten the knobs onto the potentiometer shafts.
- d) Rotate the shaft of the MUSIC VOL potentiometer fully ccw. Align the white marker on the knob (part of 40-21-MUS3) to the LIVE position on the faceplate label. Using a 0.05" Allen key, tighten the knob onto the potentiometer shaft.

Note: Make sure there is enough clearance between the concentric knobs so that rotating one does not also move the other. A piece of paper makes a good spacer when setting up the clearance.

2.3.6 Post-Installation Checks

If any preset requires adjustment, be sure this is carried out before the aircraft leaves, and that the unit and its mating connector are secured before departure. Make all required log book entries, electrical load, weight and balance amendments and other paperwork as required by your local regulatory agency.

2.3.6.1 Voltage/resistance checks

Do not attach the AA83-001 until the following conditions are met.

Check the following:

- a) Check P101, pin <1> for avionics buss voltage relative to ground.
- b) Check P101, pin <16> for continuity to ground (less than 0.5 Ω).
- c) Check P101, pins <9> <10> <11> and <12> (and <13> and <14> if applicable) for continuity to ground (less than 0.5 Ω) when the relevant switch is keyed.
- d) Check all mic, phone, music, and key lines for shorts to ground or adjacent pins. Check all key lines for correct operation.

2.3.6.2 Power On checks

WARNING

**High volume settings can cause hearing damage.
Set the headset volume control to the minimum volume
setting prior to conducting audio tests, and slowly increase
the headset volume to a comfortable listening level.**

Install the AA83-001 and power up the aircraft's systems, and turn on the radios and accessories required. Verify normal operation of all functions. Refer to Section 3 for specific operation details.

- a) Begin with only the pilot's headset installed; no hand mic. Check for correct radio operation (both receive and transmit) and ICS operation. Check yoke (or cyclic) switch action.
- b) If there is a music source in the system turn it on and verify that music is heard in all modes except PLT ISO. Check for proper mute operation.

Note: Unusual buzzes, hums or other background audio may be symptomatic of multiple grounds or noisy external systems sharing the same wire bundle. Incorrect jack wiring is a common fault, especially for passenger stations, and may cause loss of audio, a tone on the headset lines, or other problems.

- c) Plug in the copilot's headset. Check for correct radio and ICS operation. Check pilot's transmit priority. Check yoke or cyclic switch functions, if applicable.
- d) Plug in the hand mic (if applicable to the installation), and test for correct operation in all modes. It must activate the transmitter(s) in all cases.
- e) Plug in any remaining headsets, and check for correct ICS operation.
- f) To verify proper operation, all functions and levels should be checked in-flight.
- g) To verify 'fail-safe' operation, ensure that the front-panel switch is in the NORM position, and then pull the breaker or fuse that powers the AA83-001. The pilot's headset is now connected directly to the COM or audio panel, and should be checked to ensure the RX and TX functions work properly. It may be necessary to adjust the RX VOL side trimpot to ensure RX audio from the audio panel is at a suitable level for audibility.

Be sure headsets are of good quality and are installed correctly. Unless the AA83 has specifically been wired for mono operation **NEVER USE MONO AIRCRAFT HEADSETS** in the system, as they will short out one side of the AA83 power amplifier when installed in stereo jacks. This may result in eventual unit failure, which IS NOT COVERED BY WARRANTY.

Upon satisfactory completion of all performance checks, make the required log entries and complete the necessary Regulatory Agency paperwork before releasing the aircraft for service.

2.4 Continued Airworthiness

Maintenance of the AA83-001 is 'on condition' only. Periodic maintenance of this product is not required.

2.5 Accessories Supplied

Installation kit p/n AA83-IKC is required to complete the installation. The kit consists of the following:

Quantity	Description	NAT Part #
1	D-sub Socket	20-20-044
44	Contacts	20-26-703
1	Jackscrew, D-sub, Pair	20-27-002
1	Hood, D-sub, Plastic	20-29-026
1	AGC, Fast, 1 A	23-00-006
3	Screw, panhead, Phillips, Brass, Black	25-11-427
1	Knob, Fluted Concentric, Rubber	40-21-ICS3
1	Knob, Fluted Concentric, Rubber	40-21-MUS3
1	Legend and Template, AA83	43-10-083
1	Faceplate, Rectangular, AA83-001	50-04-831

2.6 Installation Drawings

DRAWING	REV.	DESCRIPTION	TYPE	SERIAL #
AA83\001\302-0	1.00	Stereo Intercom	Block Diagram	2939 and up
AA83\001\403-0	2.00	Stereo Intercom	Interconnect	2939 and up
AA83\001\405-0	2.00	Stereo Intercom	Connector Map	2939 and up
AA83\001\905-0	2.00	Stereo Intercom	Faceplate	2939 and up
AA83\001\920-0	2.00	Stereo Intercom	Mounting Diagram	2939 and up
AA83\001\921-0	1.00	Drill Template	Drill Template	2939 and up
AA83\001\922-0	2.00	Stereo Intercom	Mech. Installation	2939 and up

Section 2 ends after these Drawings

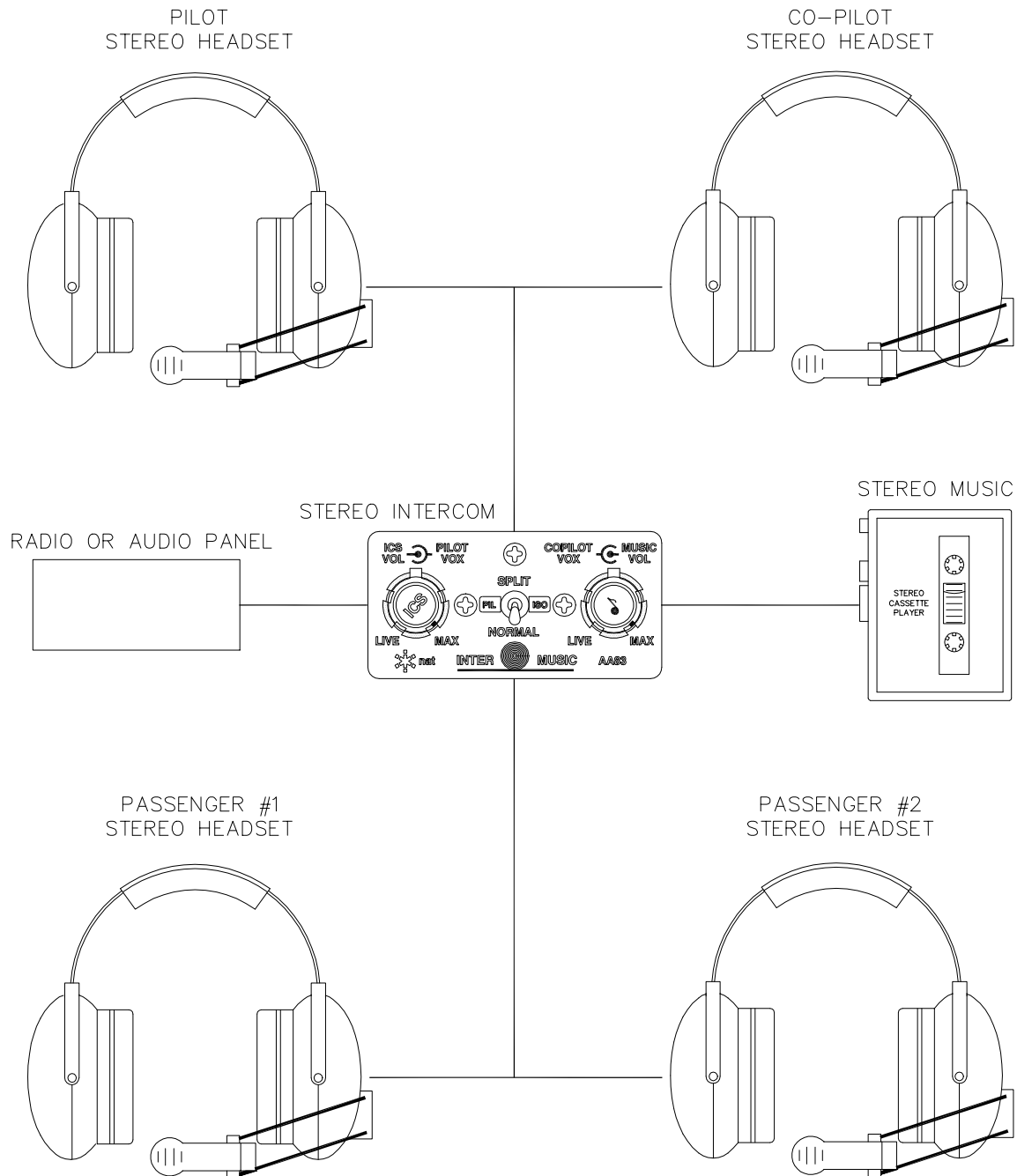

Confidential and Proprietary to NAT

		*nat NORTHERN AIRBORNE TECHNOLOGY LTD.			
REVISION	DATE	DESIGNED BY	DESCRIPTION		
1.00	MAY 6/94	K.V.	INTERMUSIC SYSTEM		
		DRAWN BY	PART NUMBER	DRAWING TYPE	SHEET
		T. MASTERS	AA83-001	BLOCK DIAGRAM	1/1
		APPROVED BY	DRAWING NUMBER	FILE NUMBER	
		NAT R&D	AA83-001\302-0	AA83-001\302-0100	
		101			

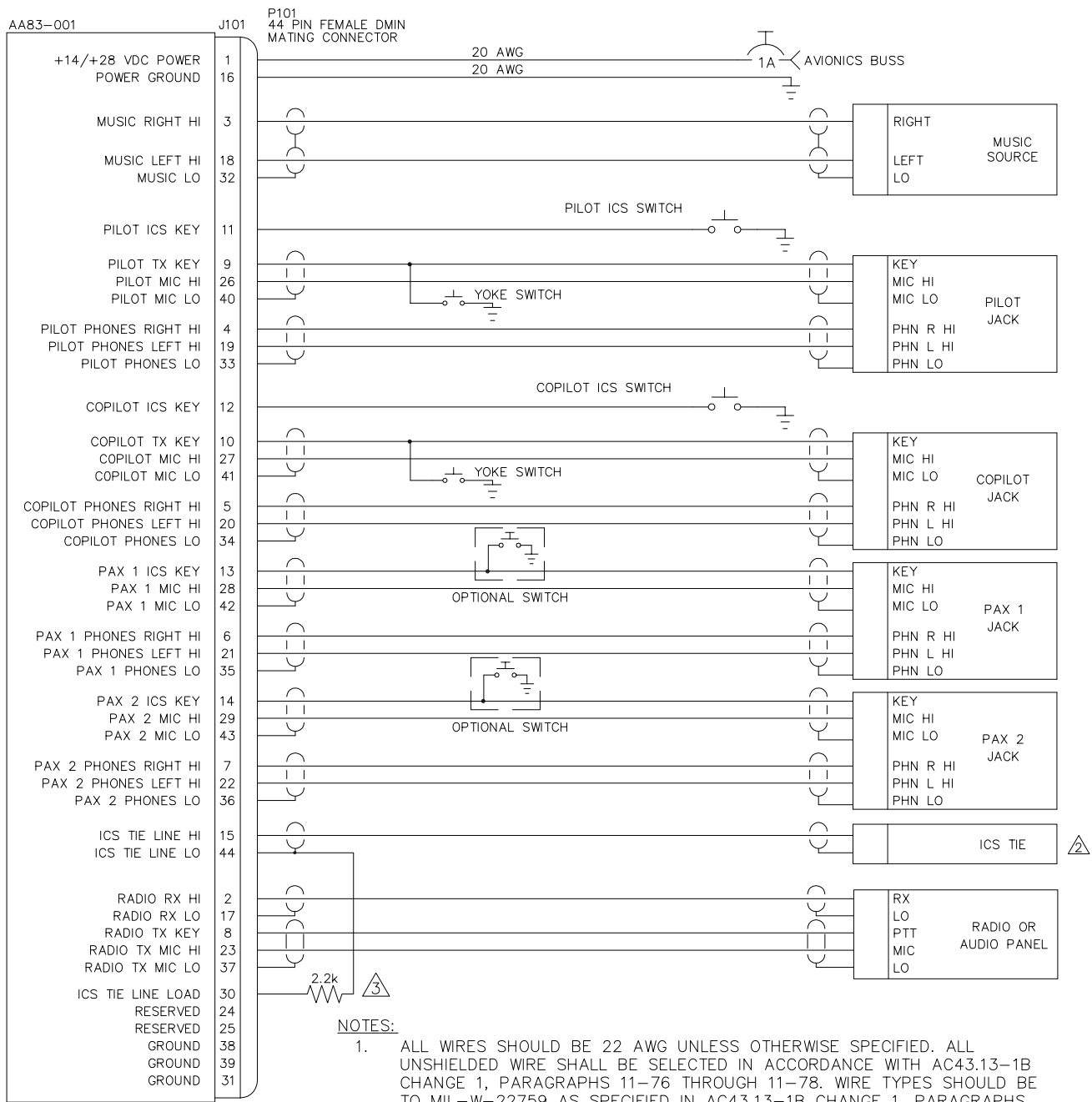

NOTES:

1. ALL WIRES SHOULD BE 22 AWG UNLESS OTHERWISE SPECIFIED. ALL UNSHIELDED WIRE SHALL BE SELECTED IN ACCORDANCE WITH AC43.13-1B CHANGE 1, PARAGRAPHS 11-76 THROUGH 11-78. WIRE TYPES SHOULD BE TO MIL-W-22759 AS SPECIFIED IN AC43.13-1B CHANGE 1, PARAGRAPHS 11-85, 11-86 AND LISTED IN TABLE 11-11. ALL SHIELDED WIRE/CABLE SHOULD BE IN ACCORDANCE WITH MIL-C-27500.
- △ TO BE USED ONLY FOR EXPANSION OF INTERCOM SYSTEM. REFER TO INSTALLATION MANUAL FOR DETAILS.
- △ USE ONLY IN DUAL INSTALLATION TO PROVIDE CONSTANT LEVEL BETWEEN SPLIT AND NORMAL MODES.

DEFINITIONS:

RESERVED:

MAY BE CONNECTED AND USED IN FUTURE. THE CIRCUITRY MAY BE PRESENT OR ADDED TO ACTIVATE THE FUNCTION. THE PIN MAY BE USED FOR TEST PURPOSES. THERE IS NO EXTERNAL CONNECTION.

CONFIDENTIAL AND PROPRIETARY TO NAT LTD.

DESIGNED	KEH	NAT NORTHERN AIRBORNE TECHNOLOGY LTD.				
DRAWN	MWS					
DATE	JUL 21/05	TITLE STEREO INTERCOM				
CHECKED	NAT 201 NAT 255					
APPROVED	NAT 114	SIZE	CAGE CODE	PART NO.	REV.	SHEET
FILE	403-0.DWG	A	3AB01	AA83-001	2.00	1/1
DWG. TYPE		INTERCONNECT		DWG. NO. AA83\001\403-0		

P101
 44 PIN FEMALE DMIN
 MATING CONNECTOR

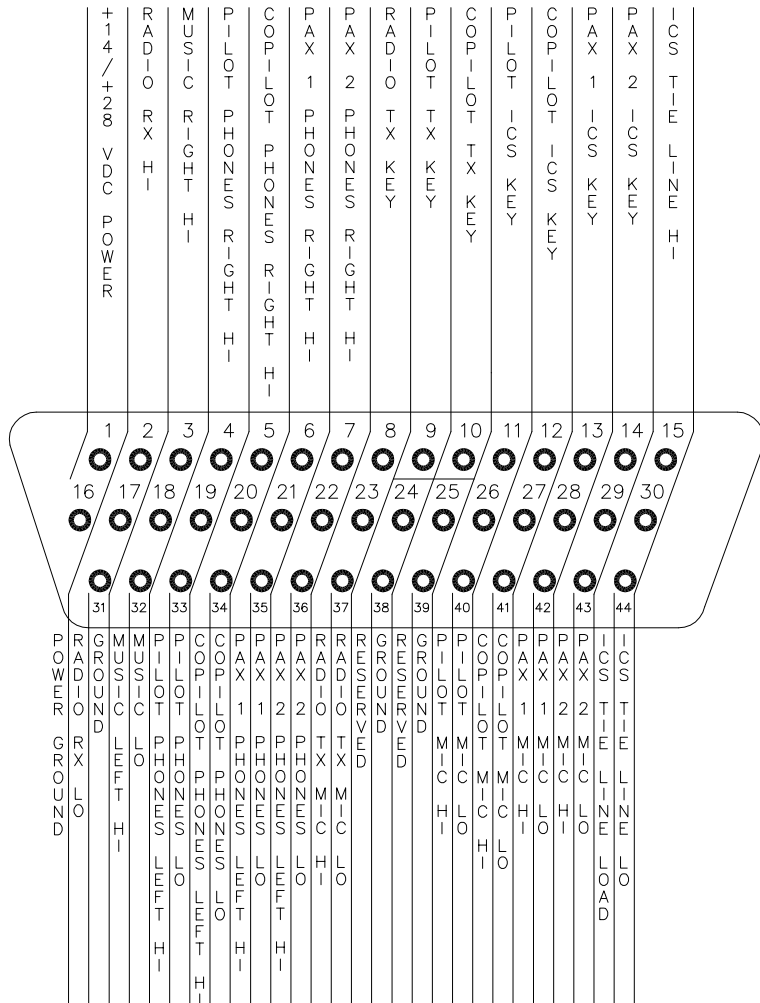



VIEW IS FROM REAR OF AIRFRAME CONNECTOR

CONFIDENTIAL AND PROPRIETARY TO NAT LTD.

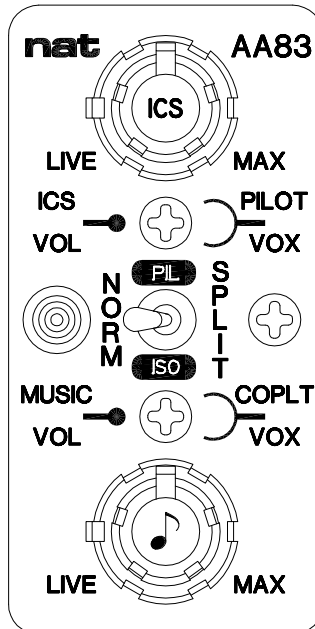
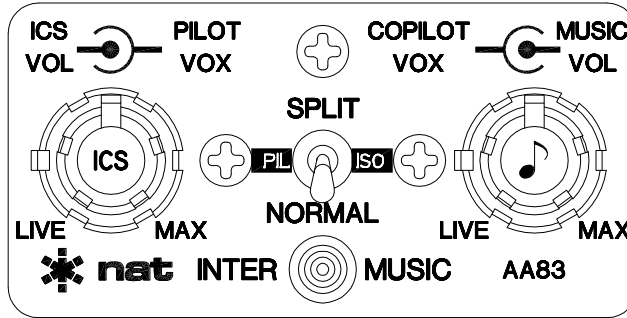
DESIGNED	KEH	nat NORTHERN AIRBORNE TECHNOLOGY LTD.				
DRAWN	MWS					
DATE	JUN 06/05	TITLE	STEREO INTERCOM			
CHECKED	<div style="border: 1px solid black; padding: 2px; display: inline-block;"> NAT NAT 201 255 </div>					
APPROVED	<div style="border: 1px solid black; border-radius: 50%; padding: 5px; display: inline-block;"> NAT 114 </div>	SIZE	CAGE CODE	PART NO.	REV.	SHEET
FILE	405-0.DWG	A	3AB01	AA83-001	2.00	1/1
DWG. TYPE		CONNECTOR MAP		DWG. NO.		AA83\001\405-0

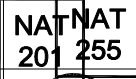

CONFIDENTIAL AND PROPRIETARY TO NAT LTD.

DESIGNED	KEH	 NORTHERN AIRBORNE TECHNOLOGY LTD.				
DRAWN	MWS					
DATE	JUL 21/05	TITLE	STEREO INTERCOM			
CHECKED						
APPROVED		SIZE	CAGE CODE	PART NO.	REV.	SHEET
FILE	905-0.DWG	A	3AB01	AA83-001	2.00	1/1
		DWG. TYPE	FACEPLATE	DWG. NO.	AA83\001\905-0	

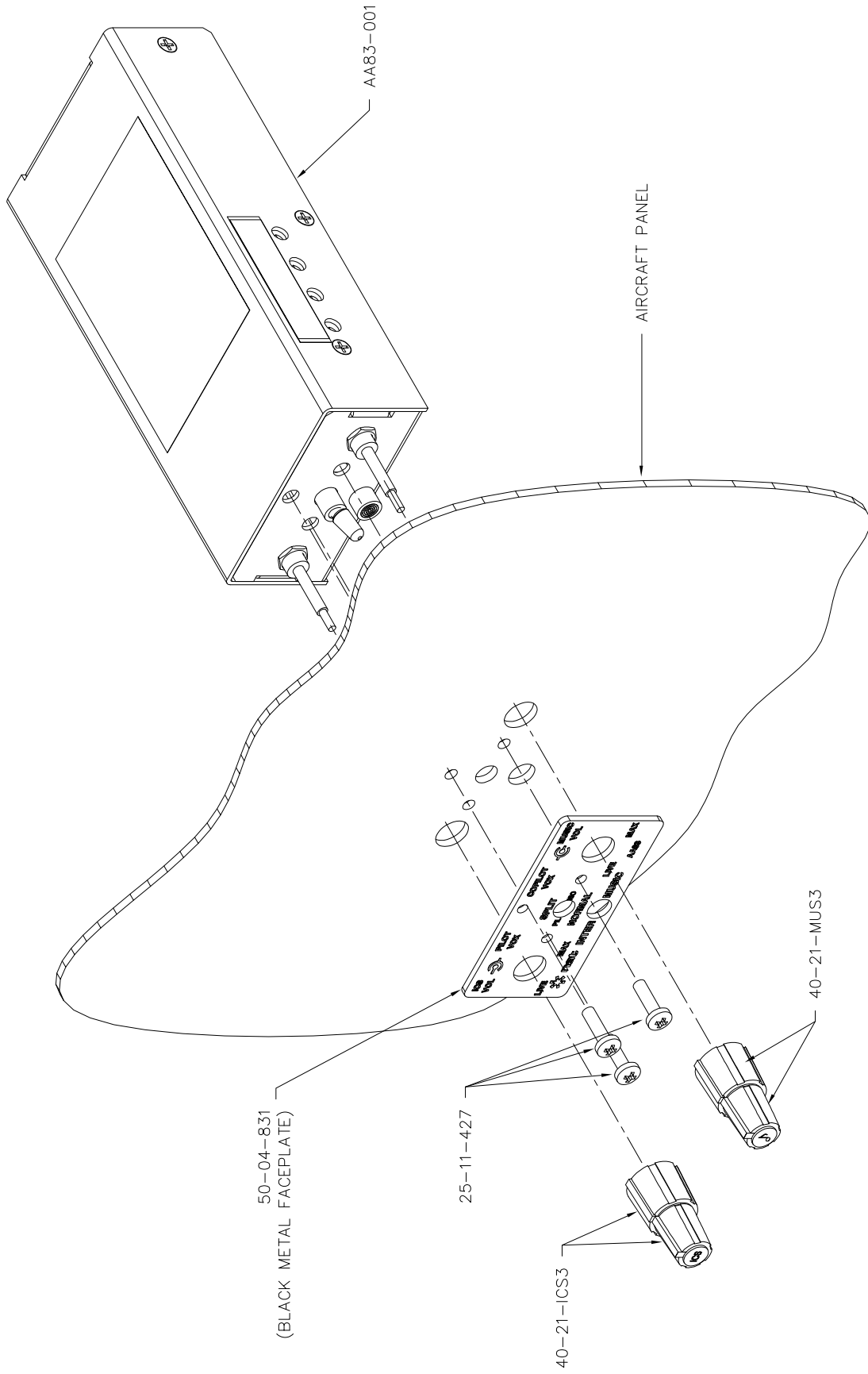

CONFIDENTIAL AND PROPRIETARY TO NAT LTD.

nat NORTHERN AIRBORNE TECHNOLOGY LTD.

DESIGNED	KEH	TITLE			
DRAWN	MWS	STEREO INTERCOM			
DATE	JUL 20/05	SIZE	CAGE CODE	PART NO.	REV.
CHECKED	NAT 201	A	3AB01	AA83-001	2.00
APPROVED	NAT 114	DWG. TYPE	MOUNTING DIAGRAM	DWG. NO.	AA83\001\920-0
FILE	920-0.DWG	SHEET			
		1/1			

AA83-001 DRILL TEMPLATE

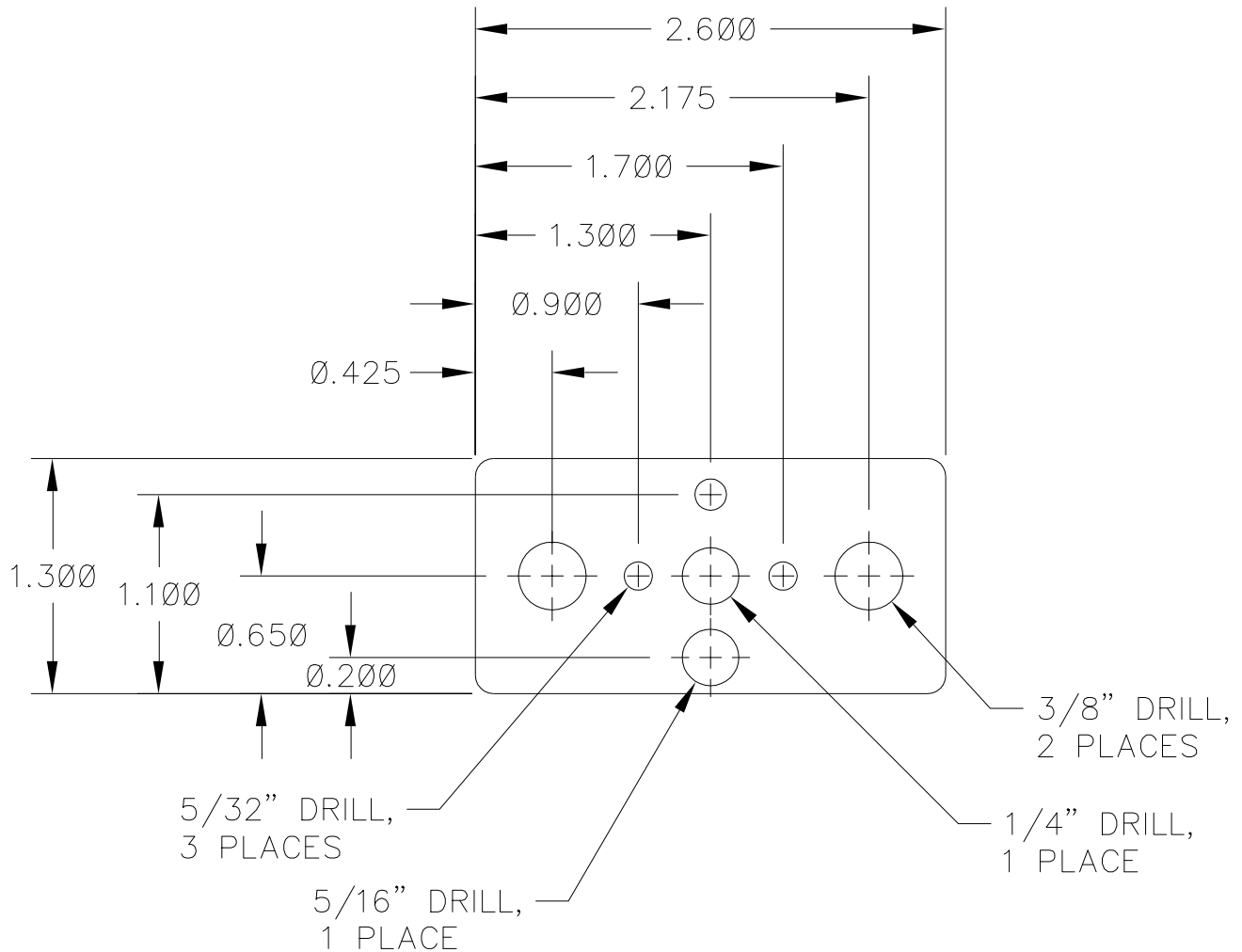

NOTE: ALL TOLERANCES ± 0.01

Confidential and Proprietary to NAT

REVISION	DATE	TOLERANCES UNLESS STATED OTHERWISE	*nat NORTHERN AIRBORNE TECHNOLOGY LTD.			
1.00	MAY 18/94	0.X=+/-0.030 DIM. IN INCHES 0.XX=+/-0.010 0.XXX=+/-0.005 0.XXXX=+/-0.0005 ANGLE=+/- 0.5 DEG.	DESIGNED BY	DESCRIPTION		
			K.V.	DRILL TEMPLATE		
			DRAWN BY	PART NUMBER	DRAWING TYPE	SHEET
			T. MASTERS	AA83-001	MOUNTING PLATE	1/1
THIRD ANGLE PROJECTION		MATERIAL/FINISH	APPROVED BY	DRAWING NUMBER	FILE NUMBER	
			NAT R&D 101	AA83-001\921-0	AA83-001\921-0100	

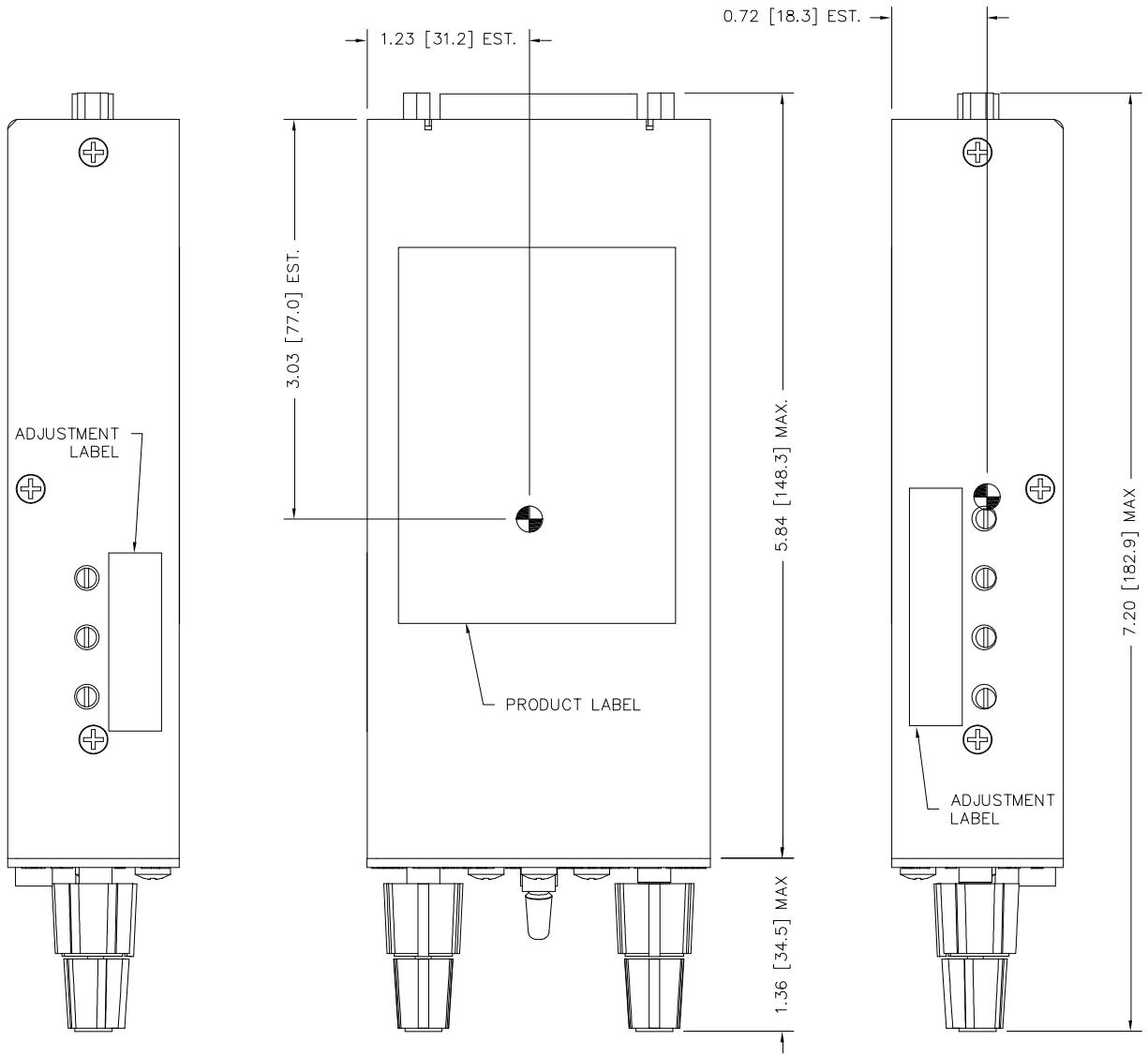

☉ CENTER OF GRAVITY

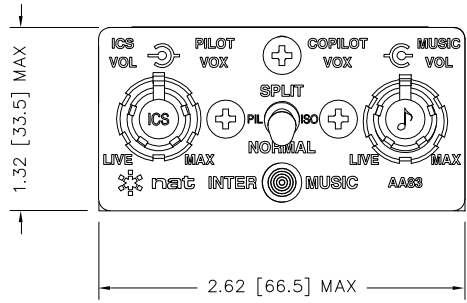

NOTES:
1. DIMENSIONING AND TOLERANCING
IN ACCORDANCE WITH ASME Y14.5M-1994

CONFIDENTIAL AND PROPRIETARY TO NAT LTD.

DIMENSIONS ARE INCHES [mm]		DESIGNED	KEH		NAT NORTHERN AIRBORNE TECHNOLOGY LTD.				
THIRD ANGLE PROJECTION		DRAWN	MWS						
MASS: 0.70 lbs. (0.32 Kg) MAX		DATE	JUN 28/05		TITLE				
MATERIAL:		CHECKED	NAT 201	NAT 255	STEREO INTERCOM				
FINISH:		APPROVED			SIZE	CAGE CODE	PART NO.	REV.	SHEET
		FILE	922-0.DWG		A	3AB01	AA83-001	2.00	1/1
					DWG. TYPE	MECH. INSTALLATION	DWG. NO.	AA83\001\922-0	

Section 3 Operation

3.1 Introduction

Information in this manual consists of the functional and operational procedures for the AA83-001 InterMUSIC™ Stereo Intercom, serial numbers 2939 and later.

3.2 General Operation

The AA83-001 is a 4-place stereo voice-activated intercom, providing full intercom capabilities for pilot, copilot and two passengers (PAX). The AA83-001 has a built-in tieline with tie/split capability, providing support for additional users in a multi-unit system.

The AA83-001 also provides transmit capability for pilot and co-pilot to a single COM radio or audio selector panel. The AA83-001 accepts stereo music inputs from either portable or fixed entertainment systems to produce high quality stereo headset output.

The InterMUSIC™ family of stereo intercoms allows several installation configurations - from single unit systems, to fully independent stations for the pilot, copilot and passengers. For expanded systems, tie line connections are compatible with other NAT systems including AA82, AMS4x and AA9x series units.

3.2.1 Stereo & Intercom Special Features

The stereo music audio is muted during transmit or intercom operation and when radio receive audio is detected, permitting greater intelligibility of incoming transmissions. The AA83-001 muting depth adjustment ranges from complete music muting to gentle background music on command, with a fast attack and slow level return for optimum user comfort. Each microphone is individually gated, for the best possible noise performance during VOX operation. A front panel annunciator allows easy visual setting of the VOX threshold, and also indicates transmit operation.

3.2.2 Communication Functions

The AA83-001 provides full boom-mic transmit and ICS functions for the pilot and copilot, and provides ICS and radio monitor operation for two additional passengers. Pilot priority on transmit and pilot isolation/fail-safe (direct connection to the aircraft radio system) are standard features on all NAT intercom systems. The AA83-001 can support PTT ICS operation for all users, and can be wired to cyclic/yoke switches for both TX and ICS functions.

3.2.3 Important Operating Considerations

Ensure headsets are of good quality and are installed correctly. **NEVER USE MONO AIRCRAFT HEADSETS** in this system unless the installation has been specifically wired for mono operation, as they will short out one side of the AA83-001 power amplifier when installed in stereo jacks. This may result in eventual unit failure, which IS NOT COVERED BY WARRANTY. Use **only stereo headsets** with this system, and be sure the aircraft is placarded appropriately.

3.2.4 Installation Adjustments

Using individual level trimpots, an approved dealer can adjust the following audio levels during service, or at the time of installation.

- Music mute level
- Music Bass level
- Music balance
- RX Balance
- RX volume level
- ICS Balance
- ICS Bass level

3.3 Controls and Indicators



3.3.1 ICS VOL/PILOT VOX

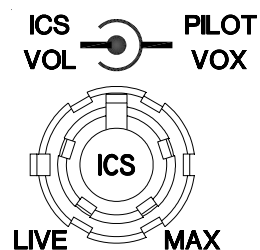

This control is a fluted concentric rubber knob on the left side of the front panel.

The inner (front) knob is the **ICS VOL** control, which is used to set Intercom volume. It is at minimum volume when fully counter-clockwise (ccw). As the knob is rotated clockwise (cw), the ICS volume for crew and PAX increases. The ICS is muted during transmit operations.

The outer (rear) knob is the **PILOT VOX** control, that controls VOX for the pilot only. For full information on VOX operation, see section 3.3.3 below.

3.3.2 MUSIC VOL/COPILOT VOX

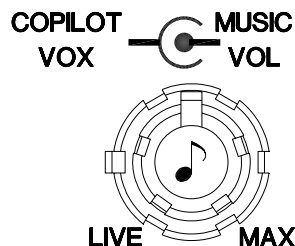

This control is a fluted concentric rubber knob on the right side of the front panel.

The inner (front) knob is the **MUSIC VOL** control, which is used to set normal music volume. The volume can be adjusted from minimum (fully ccw) to maximum (fully cw).

The outer (rear) knob is the **COPILOT VOX** control, that controls VOX for the copilot and passengers. For full information on VOX operation, see section 3.3.3 below.

3.3.3 VOX Operation

The VOX control is used to set the level of audio required to activate the microphones. The AA83-001 provides three modes of intercom operation, selected by the position of the VOX control.

LIVE ICS When the VOX control is positioned fully ccw to the **LIVE** position, all mics will be live, and any sound picked up will be processed by the ICS system (hot mic).

KEYED ICS When the VOX control is positioned fully cw to the **MAX** position, the intercom will be in a keyed-only mode.

VOX ICS When the VOX control is positioned between fully cw and fully ccw, the intercom is in VOX mode. To establish the VOX threshold, rotate the control ccw until the LED turns red, and then rotate the control cw until the LED goes dark. Continue turning the control cw until the desired voice sensitivity is set.

3.3.4 Annunciator

The front panel annunciator is a bi-colour LED that shows intercom status.

If the LED is illuminated green, it indicates transmit activity, and if it is red, it indicates VOX activity. For transmit with sidetone or mic activity, it will illuminate amber. The green LED also indicates a possible stuck mic if still lit after transmission is concluded.

3.3.5 MODE Control

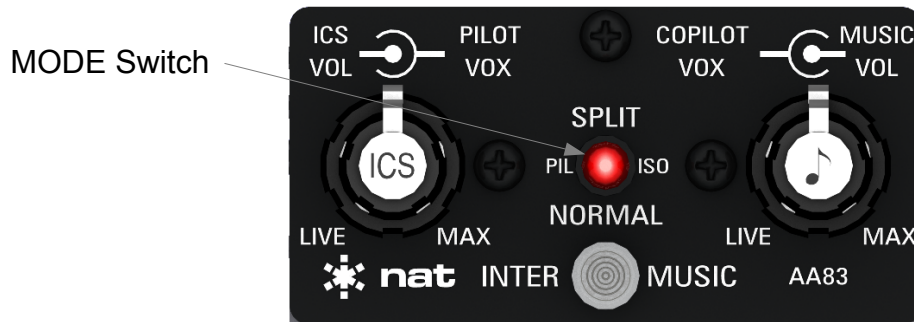

The mode control is a three-position toggle switch used to select the operational mode of the unit. The selectable positions are SPLIT, PIL ISO and NORMAL. These modes are described fully in sections 3.3.5.1, 3.3.5.2 and 3.3.5.3 below.

3.3.5.1 NORMAL Operation

In normal use, the AA83-001 serves as a common intercommunication system for up to four users, and a flow-through interface for connection to the ship's external communication system. The NORM mode (default) permits everyone on the system to talk to each other, listen to music, and hear all radio communications.

Radio transmit functions may be initiated by either the pilot or the copilot. The pilot has priority.

In NORM mode, external tie line users are included in the ICS communications.

3.3.5.2 PIL ISO (Pilot Isolation) Operation

In normal operation, the pilot, copilot, and passengers hear the same signals from the aircraft communication system. Sometimes this is not desirable from the pilot's perspective, for instance during communication with the tower on approach, or when discussions on the intercom would be a distraction. Many times the copilot position is simply another passenger, and the pilot may wish to be isolated from them.

PILOT ISO mode separates the pilot from the intercom network, allowing confidential radio communications without interference from the copilot or passenger intercom or music. The pilot has no ICS operation, and all signals are presented in mono format during this mode. All other users are unaffected and continue to use the entertainment and intercom functions of the AA83-001.

While in **PILOT ISO** mode, the pilot maintains complete control of all the radio functions of the intercom, and the pilot mic and TX keyline are directly connected to the transceiver. The pilot phones are driven by the transceiver.

The copilot and passengers will be unable to monitor any transceiver activity, although they retain full ICS and music functions.

This mode is 'fail-passive', meaning that it requires no power to operate and is the same mode the box goes into *automatically when power is lost to the AA83-001*. In this way, switch over is immediate for the pilot and there is no possibility of lost communication because of a lack of pilot action. Note that the pilot's boom mic is sent directly to the radio in this mode, and only a PTT key input is needed to transmit.

Note: In this mode, the receive/sidetone levels may require adjustment at the audio source.

3.3.5.3 SPLIT Operation

Operation in SPLIT Mode is similar to NORM mode, but if the AA83-001 is connected as part of a multi-unit system, the SPLIT mode allows external users to be disconnected from the AA83-001 ICS communications without requiring adjustment of the ICS Audio level.

All users are permitted to talk to each other, listen to music, and hear all radio communications.

There is provision for an external ICS tie line load to maintain the ICS audio at the same level as in NORM mode.

3.3.6 Radio Functions

There are two PTT inputs: one each for the pilot and copilot. Activation of either PTT input connects the user's MIC to the radio, and activates the output PTT to the radio.

Sidetone audio input is provided from the radio, not by the AA83-001 microphone circuits. Transmit sidetone audio utilizes AA83-001 Radio RX audio and phones driver circuits.

Radio RX/sidetone is a mono signal, but RX balance control may be adjusted to provide spatial displacement to aid user in quick signal identification.

Note: A priority transmission feature allows the pilot to override the copilot.

3.3.7 Muting Logic

When transmitting, any music will be muted quickly, and will slowly return when transmission is completed. Music will also be muted when ICS or RX functions are active. The degree of muting is set at the time of installation. The relative volume of the music can be changed from the front panel by the knob marked with a musical note.

Below is a simple chart to aid in understanding audio switching in the **NORMAL** Operation mode.

The following terms are used:

'Active' - Function being used.

'Muted' - Functions that are overridden by the active condition.

'Idle' - Functions that are not active, but still available for use.

	↓ Affect on other functions ↓				
Active feature→	Music	ICS	RX	Pilot TX	Copilot TX
Music→	Active	Idle	Idle	Idle	Idle
ICS→	Muted	Active	Idle	Idle	Idle
RX→	Muted	Idle	Active	Idle	Idle
Pilot TX→	Muted	Muted	Idle	Active	Muted
Copilot TX→	Muted	Muted	Idle	Idle	Active

3.3.8 Automatic Fail-safe

In the event of a power failure, automatic fail-safe operation will be activated. It can also be enabled by pulling the AA83-001 circuit breaker. Fail-safe mode routes the pilot's phones, mic audio, and mic PTT directly to the COM radio.

During transmit mode, the pilot mic is directly connected to the transceiver mic. Mic bias is provided by the transceiver, not the AA83-001. The pilot TX keyline is directly connected to the transceiver. The sidetone audio is directly connected from the audio source to the pilot phones.

During receive mode, receive audio is directly connected from the audio source to the pilot phones.

In both modes, copilot and passengers have no ICS, music, sidetone, or receive functions.

Note: In Automatic Fail-Safe mode, the receive/sidetone levels may require adjustment at the audio source.

The pilot should confirm that all aspects of Automatic Fail-Safe operation are working before accepting the aircraft into service.

End of section 3

